







































ВНИМАНИЕ
НА ДЕТСКОЙ
ПЛОЩАДКЕ
ЗАПРЕЩАЕТСЯ:
Использование качелей, горки и других элементов конструкции для игр, не предусмотренных производителем.
Использование элементов конструкции для игр, не предусмотренных производителем.
Использование элементов конструкции для игр, не предусмотренных производителем.
Использование элементов конструкции для игр, не предусмотренных производителем.

LEBER

CONTENT

Leber is	5		Freestanding play equipment	143	
“Moskvich” playhubs	17		Sports and play systems	185	
Scientific playgrounds	31		Trampolines	199	
“Urban” playhubs	41		Geoplastics	205	
“Brium” playhubs	85		Rope Climbing Playgrounds	213	
“Antarctic” playhubs	91		Street workout	225	
“Formix” playhubs	95		Fitness stations	235	
“Reuleaux” playhubs	103		Fencing of the sports ground	245	
“Mavericks” playhubs	109		Dog agility areas	249	
Leber natural series	115		Outdoor furniture	255	

- | | | | | | |
|---|--|--|---|---|---|
|  Climb |  Think |  Hang in arms |  Socialize |  Rock |  Workout |
|  Sensory |  Crawl |  Balance |  Swing |  Glide |  Dogs |
|  Slide |  Rotate |  Sway |  Themed |  Jump | |



LEBER IS

Leber is the largest manufacturer of children's playground equipment in Russia.

For 14 years, we have set the standards for quality and safety in urban development.

We were the first company in Russia to export playground equipment to international markets.

Our playground complexes are already installed in the UAE, Saudi Arabia, Mongolia, Jordan, Kazakhstan, Uzbekistan, Armenia, and other countries.

We are proud to create safe and functional playgrounds that bring joy to children all around the world!



Leadership and Scale:

More than 10,000 of our playgrounds are spread across Russia, welcoming millions of children every day.



International Recognition:

We are proud to have won the prestigious 'Exporter of the Year' award.



Full Production Cycle:

Our company includes a production complex, warehouse facilities, construction and installation management, our own fleet, design and engineering departments, and a dedicated customer service team.



Quality and Safety:

Our products come with global quality and safety certifications. We offer a warranty of up to 15 years.

SUSTAINABILITY OF LEBER



FOREST CONSERVATION AND RESTORATION

We obtain our wood only from suppliers who possess a forestry certificate, ensuring their commitment to reforestation initiatives. Thanks to our support this year, trees have been planted in over 50 hectares across seven regions in Russia. We are committed to ensuring that 100% of the forest areas used for harvesting materials for our playgrounds will be restored.



LOW-CARBON RENEWABLE ENERGY

Low-carbon renewable energy is a key component of our manufacturing processes, leading to a 15% reduction in greenhouse gas emissions. These renewable sources provide a sustainable, long-term answer to our energy needs in production, without consuming natural resources. Leber is committed to lessening its carbon footprint by adopting eco-conscious energy sources.



WASTE RECYCLING

At Leber, we specialize in metalworking and paper recycling. By processing metallic waste and scrap into new materials, we significantly lower natural resource consumption and energy costs. Recycling metal scrap minimizes waste that would otherwise occupy landfill space for centuries and cuts sulfur dioxide and carbon emissions, improving air quality. By recycling paper, we decrease the need for new trees, supporting a circular economy where materials are reused, and waste is repurposed into new resources.



RECYCLED PLASTIC

We incorporate granules from recycled plastic, mainly PET bottle caps, to minimize plastic waste. This approach reduces the need for natural resources and significantly lessens landfill waste, thus easing environmental strain. Additionally, this recycling process helps lower greenhouse gas emissions, enhancing the ecological balance.

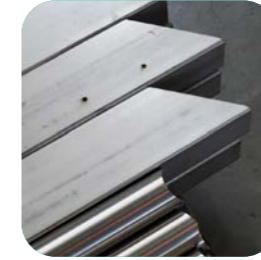

RECYCLING METAL

In our production, we regularly incorporate recycled metal, which cuts down on the necessity for raw natural resources and minimizes waste. This recycling process consumes much less energy than producing metal from new sources, resulting in a decrease in non-renewable energy usage and lower greenhouse gas emissions. Additionally, metal recycling helps conserve natural resources like iron ore, coal, and limestone, which are used in primary metallurgy.



WASTE HEAT

We use production waste like sawdust, shavings, wood offcuts, and material residues as an efficient heat source. This method not only cuts energy costs but also reduces carbon emissions by burning these materials in controlled settings, thus preventing methane emissions from landfill decomposition. This practice strengthens our sustainability by reducing dependency on external energy sources.



EFFICIENT RESOURCE USE

We have installed automatic shutdown systems for machines during off-hours. This reduces energy consumption and alleviates the load on the energy infrastructure, leading to lower CO2 emissions. Additionally, these systems help extend the life of our equipment, reducing production waste and resource use.



GREEN SOLUTIONS FOR ROPES

Each strand of our polyester ropes is wrapped in recycled material. This process makes the ropes highly durable and resistant to vandalism, while also increasing their environmental sustainability. The rope fasteners are crafted from recycled aluminum cans, reducing both energy consumption and waste.



TECHNOLOGIES

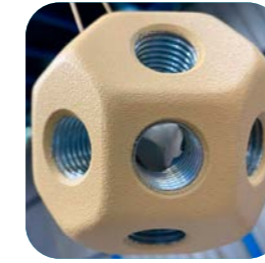

MARCHI NODE

In the production of connecting elements for our products, we employ the patented "Marhi Node" technology. This ensures a high level of joint strength, which is particularly important for structures subjected to intense loads.



WELDING ROBOT

With the help of the robot, we developed a technology for creating a single continuous weld. This has significantly improved the quality of parts by enhancing the welding process, resulting in stronger and more reliable connections.



SHOT BLASTING

After welding, all metal surfaces are treated with abrasive shot blasting. High-speed abrasive particles clean the surface, effectively removing rust, scale, old coatings, and other contaminants. This process minimizes the risk of corrosion, improves the adhesion of polyester powder paint, and enhances the product's resistance to mechanical stress.

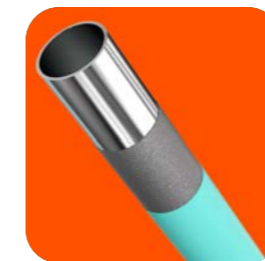

LEBER ZINC PROTECT (CORROSION PROTECTION)

Leber Zinc Protect significantly enhances the corrosion resistance of metal products, making them four times more resistant to rust. This process ensures the quality and longevity of Leber equipment, even in extremely humid climates.

TECHNOLOGIES



LEBER DURABLE PAINTING (SPECIAL POWDER COATING)

Using our Leber Durable Painting technology, we apply eco-friendly powder coatings that deliver durable, safe, and visually appealing finishes. Our powder compositions include polyester, epoxy, and hybrid systems. The paint is designed to withstand mechanical damage and environmental influences, significantly extending the lifespan of our products.



METAL PASSIVATION

We treat metals with a special chemical compound that significantly increases their resistance to corrosion. This is followed by grinding and polishing to achieve a "mirror finish" Passivation creates a thin protective layer on the metal surface, preventing contact with aggressive environments, such as moisture.



ADDITIONAL PACKAGING FOR LONG-DISTANCE SHIPPING

We offer additional packaging services for equipment that needs to be transported over long distances. We select the type of packaging for each case individually, ensuring the highest level of protection. Proper packaging and careful loading of equipment into the vehicle are crucial to its preservation during transportation. We ensure that your equipment is delivered to its destination in the same condition it left our production complex or warehouse.



VR-TECHNOLOGY

We use virtual reality technology for designing children's play complexes and furniture. This allows us to examine every detail of our project before physical implementation. It enables us to better understand how users will interact with the product and assess how well it will fit into its environment.



LEBER HOT ZINC PROTECT (ENHANCED CORROSION PROTECTION)

Leber Hot Zinc Protect offers decades of corrosion protection through the process of hot-dip galvanizing. Metal products are immersed in molten zinc at approximately 450°C, forming a durable, rust-resistant coating. The thick zinc layer can protect the metal for decades, with a typical lifespan of up to 50 years or more under normal conditions.



PACKAGING DEPARTMENT

To ensure long-term storage and transportation, we securely package all our equipment. Each product is wrapped in protective materials and then placed in a sturdy box or other container that prevents direct contact with the external environment. The packaging provides reliable protection against shock, moisture, dust, and other external influences.



MATERIALS



PINE



ASPEN



ACACIA



ROUND WOOD



LARCH



**GLUED TIMBER
ROUNDED**



**GLUED LAMINATED
TIMBER**

MATERIALS



ROPES

We combine ropes from different materials — nylon, polyester, polypropylene and steel. Inside we use aluminum stainless steel sleeves. Such ropes provide high strength and resistance to breakage, while remaining soft and elastic.



SLIDES

We buy the tall slides in Russia. They are manufactured using the rotomolding method, which ensures high density and quality. These are durable and safe structures, ideal for children's playgrounds.



HPL WITH UV PROTECTION

It is not plastic, but a natural material based on thermoactive resins and paper. It is extremely resistant to external influences - impact, moisture, extreme temperatures. HPL-plastic differs from its analogs by high hardness, durability, non-toxicity. HPL reliably protects from ultraviolet rays, which prevents fading and destruction of the material under the influence of the sun.



HDPE (HIGH-DENSITY POLYETHYLENE)

High Density Polyethylene (HDPE) is characterized by its strength and resistance to mechanical damage, making it suitable for a variety of structural applications.



STAINLESS STEEL

Wear-resistant material, resistant to corrosion. Shot blasted. After protection with Leber Zinc Protection, the steel surface is perfectly coated with paint. Thanks to this, the elements retain their aesthetic appearance in case of sudden temperature changes. Stainless steel is characterized by high strength and durability, it is resistant to mechanical damage and aggressive environmental influences. This material is easy to clean and does not require complicated maintenance, making it ideal for heavy-duty applications



CARBON STEEL

The basis for the structural elements of playgrounds. The strength and rigidity of carbon steel ensures the reliability of the play equipment. It is guaranteed to withstand significant loads and frequent use. Carbon steel is not subject to deformation, which gives stability and safety to the structures.



STAINLESS STEEL FASTENERS

Creates strong and durable joints between different components and structures of equipment on playgrounds and sports grounds. Provides stability of playgrounds. It does not have sharp edges, which prevents children's traumatism.



"MOSKVICH" PLAYHUBS



“MOSKVICH” PLAYHUBS

Moskvich playhubs are unique, custom-designed play areas created specifically for each location. These are complete recreational spaces with their own themes and sets of activities, providing an enjoyable and comfortable experience for both children and adults.

Moskvich playhubs, with their diverse design, are tailored to children of different ages and recreate imaginative worlds — from dinosaurs and Native American life to wildlife and a giant piano. Children can spend hours exploring these creative environments. Each play system is designed to develop cognitive, social-emotional, creative, and physical skills.

4 SIMPLE STEPS TO CREATE A PLAY SPACE WITH MOSKVICH PLAYHUB:

1. IDEA AND CONCEPT

We start by understanding the client’s vision and needs. Our team of designers and architects works closely with the client to create a unique concept for the play space. Drawing inspiration from the project’s features and surroundings, we offer creative and innovative solutions that will bring joy to children and seamlessly blend into the environment.

3. PRODUCTION AND TEST ASSEMBLY

Once the project is ready, we proceed to production. Using modern equipment, we create high-quality and durable play elements. Each element undergoes test assembly to ensure its reliability and safety. Then, the products are sent for final adjustments and painting.

2. DESIGN AND DEVELOPMENT

Once the concept is approved, we move on to detailed design. We create the technical documentation, taking into account all aspects of safety and functionality. We develop prototypes and models that clearly demonstrate the future playhub and allow for necessary adjustments.

4. INSTALLATION AND COMMISSIONING

The final stage is the installation of the playhub. We conduct on-site inspections and testing to ensure the space meets all required standards and that the original vision is fully realized. Once complete, the Moskvich playhub is 100% ready for use.



13.175

Play System Portal: Cube

width	length	height	fall height
6 710 mm	12 477 mm	5 929 mm	1 503 mm

Age range: 7-12 years

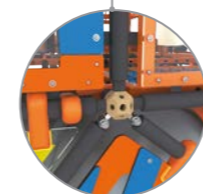
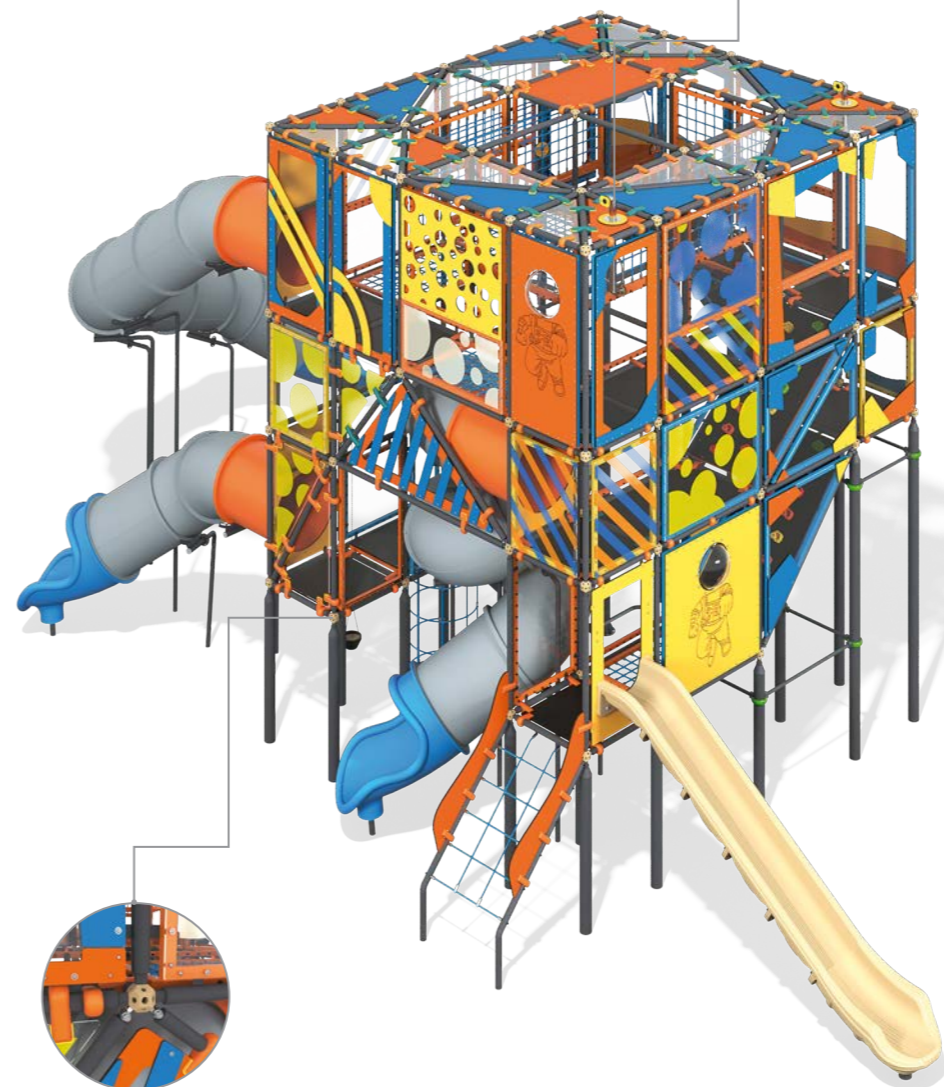

17.047

Swing Portal

width	length	height	fall height
1 372 mm	5 939 mm	2 651 mm	1 500 mm

Age range: 3-12 years



11.019

Seesaw Portal

width	length	height	fall height
482 mm	2 652 mm	676 mm	527 mm

Age range: 3-12 years

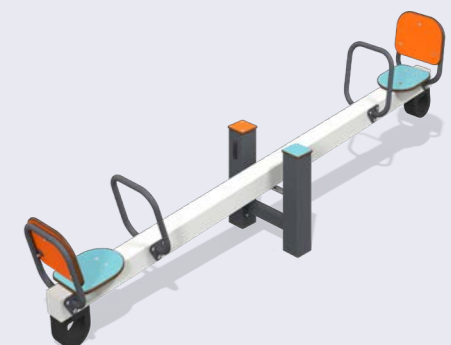

14.022

Carousel Spiral

width	length	height	fall height
1 664 mm	1 664 mm	859 mm	426 mm

Age range: 3-12 years

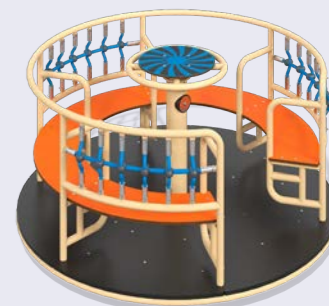



13.192

Play System Towers

width	length	height	fall height
9 747 mm	10 822 mm	5 492 mm	3 000 mm

Age range: 7-12 years



11.016

Seesaw Crane

width	length	height	fall height
449 mm	3 813 mm	2 380 mm	1 245 mm

Age range: 3-12 years



11.017

Seesaw Apples and pears

width	length	height	fall height
482 mm	2 648 mm	676 mm	680 mm

Age range: 3-12 years

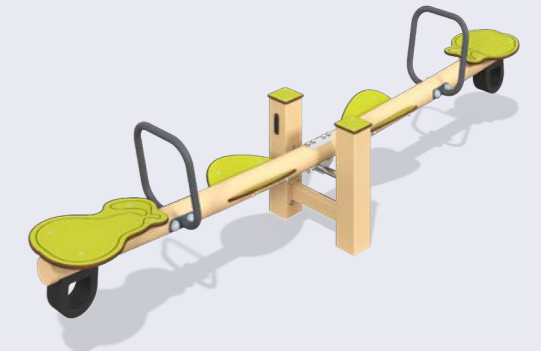

16.052

Spring Rider Stump

width	length	height	fall height
587 mm	765 mm	854 mm	410 mm

Age range: 3-7 years

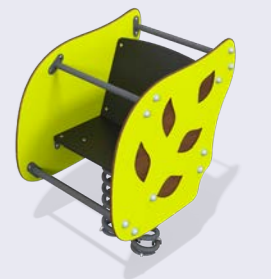



TOWERS

“Towers” are suitable for play in any weather. Canopies provide protection from the sun and precipitation, while a stainless steel wire mesh ensures safety throughout the complex. Children can explore the structure or relax in a hammock. There is a separate play module for children under 6 years old.

PLAY VALUE

Play value combines the attractiveness and significance of the play experience for children. It arises from a mix of several factors: engaging play mechanics, the level of involvement, and the sense of satisfaction. Play value motivates the child to continue playing, improving cognitive skills, and exploring observed effects. Thus, the play item becomes an important educational tool.

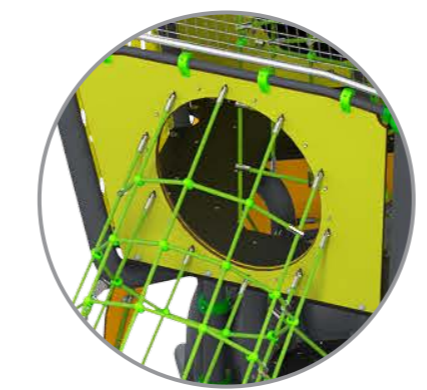

Physical activity associated with exploring the structure and using various play elements promotes the development of gross and fine motor skills, coordination, and overall physical endurance.

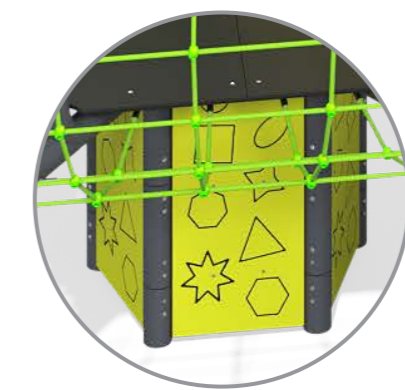

The complex features additional activities and puzzles that support the development of problem-solving skills and logical reasoning in children.

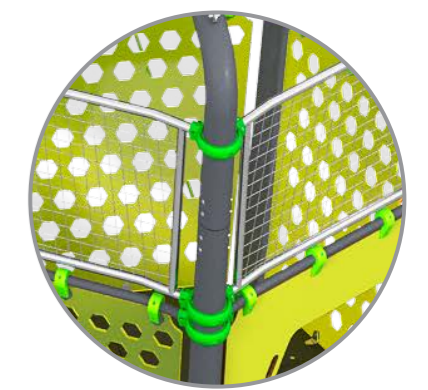

The protection and comfort provided by the canopies and mesh reduce anxiety and enhance the sense of security, especially important for younger children.



13.722

Play System Towers Mini

width	length	height	fall height
7 651 mm	8 065 mm	5 355 mm	2 850 mm

Age range: 7-12 years

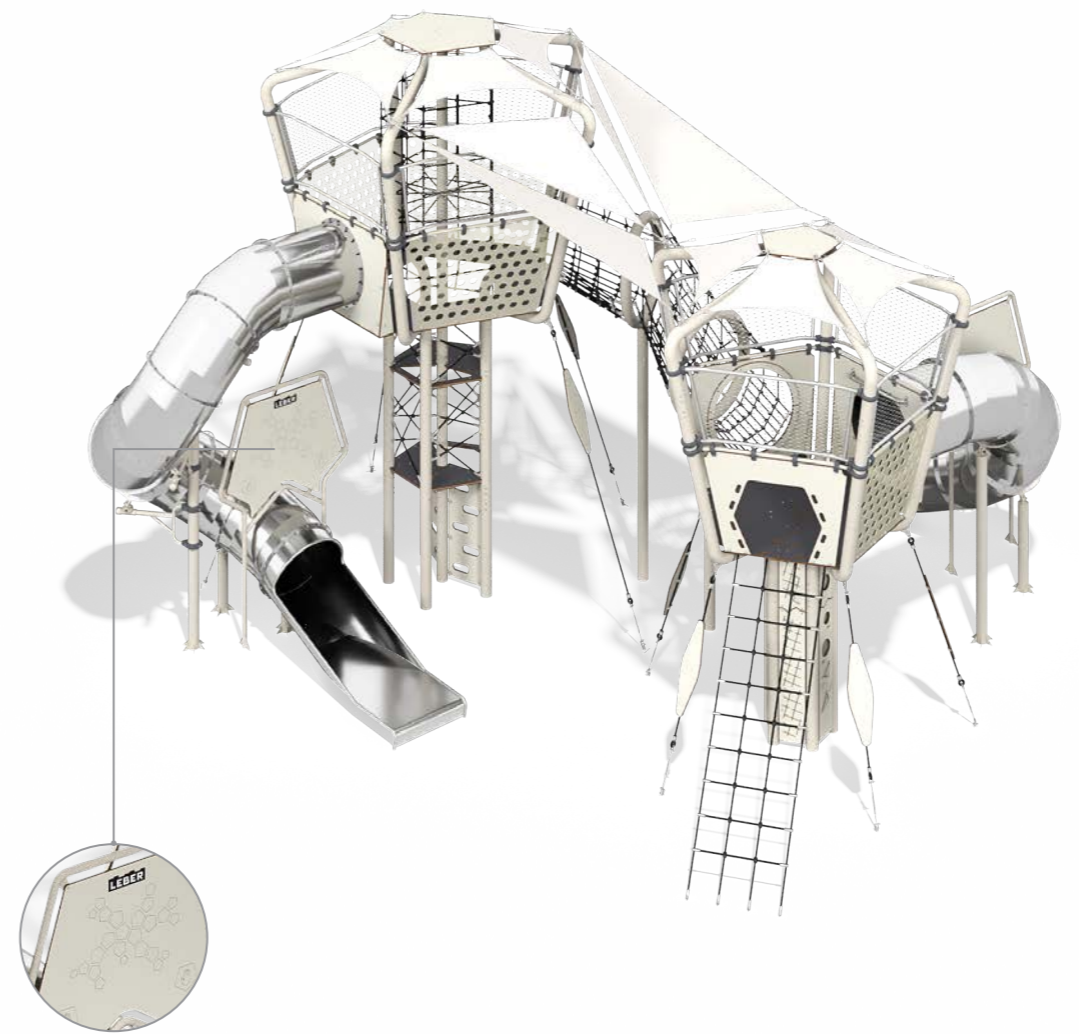

17.111

Triple swing

width	length	height	fall height
1 000 mm	10 100 mm	3 000 mm	1 655 mm

Age range: 3-12 years

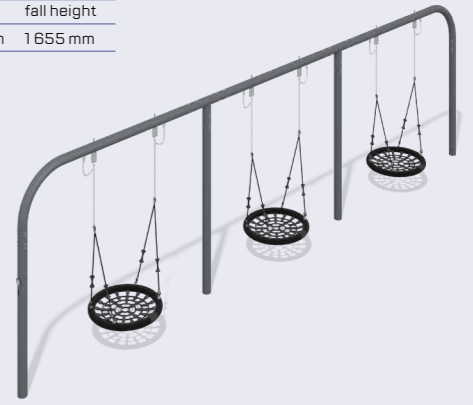

30.043

Playing element Labyrinth 2

width	length	height	fall height
200 mm	401 mm	2 197 mm	-

Age range: 7-12 years



44.002

Educational Module Gates

width	length	height	fall height
340 mm	466 mm	700 mm	-

Age range: 3-12 years





13.108

Play System Discovery

width	length	height
9 800 mm	12 200 mm	5 600 mm

Age range: 7-12 years



13.109

Play System Climbing

width	length	height
14 600 mm	18 800 mm	6 800 mm

Age range: 7-12 years



13.103

Play System Urban

width	length	height
11 060 mm	12 820 mm	8 350 mm

Age range: 7-12 years



13.106

Play System Symbol

width	length	height
12 700 mm	14 400 mm	5 900 mm

Age range: 7-12 years



SCIENTIFIC PLAYGROUNDS

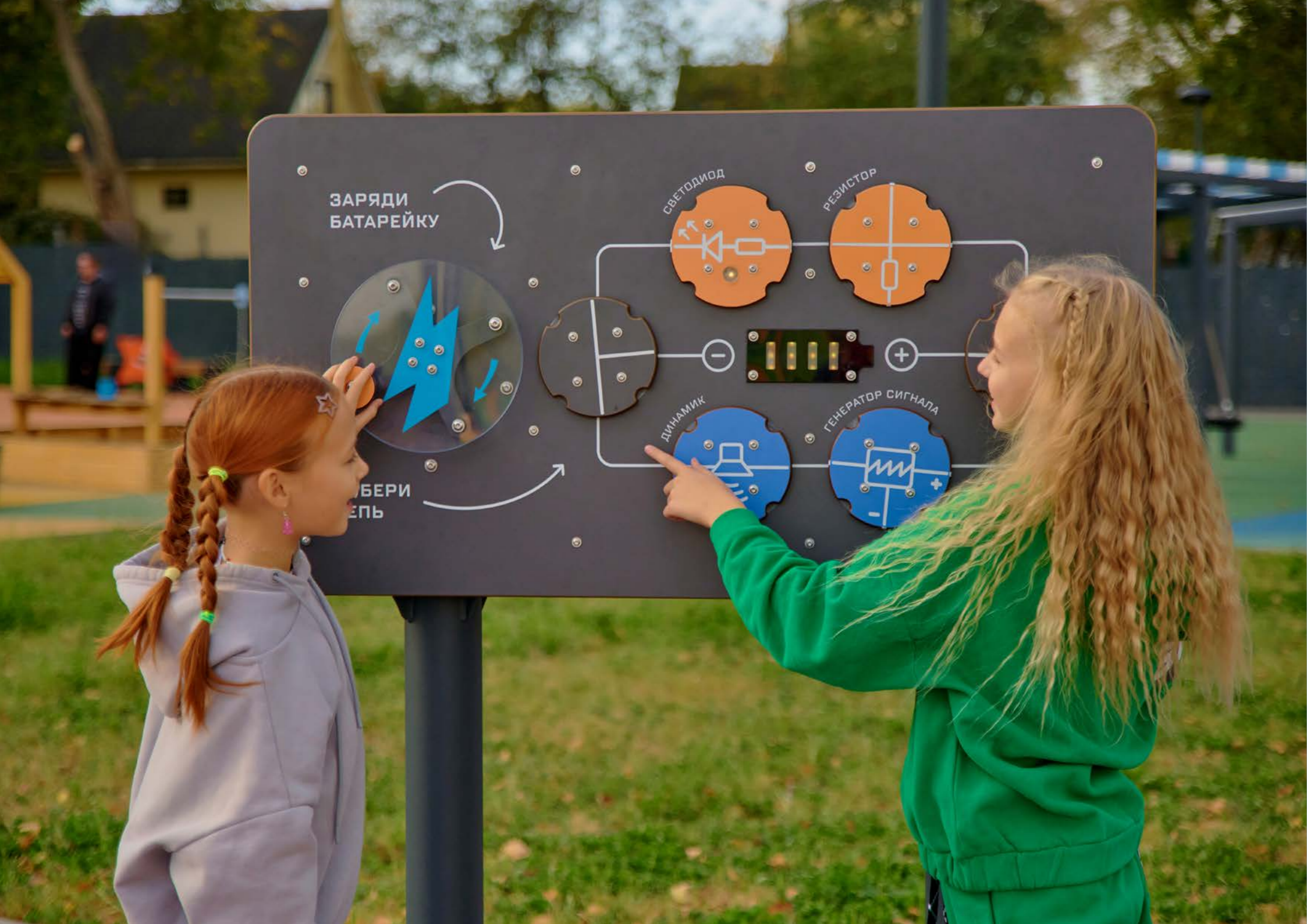



37004

Scientific module Science

width	length	height	fall height
3 890 mm	6 284 mm	7 833 mm	3 000 mm

Age range: 7-12 years

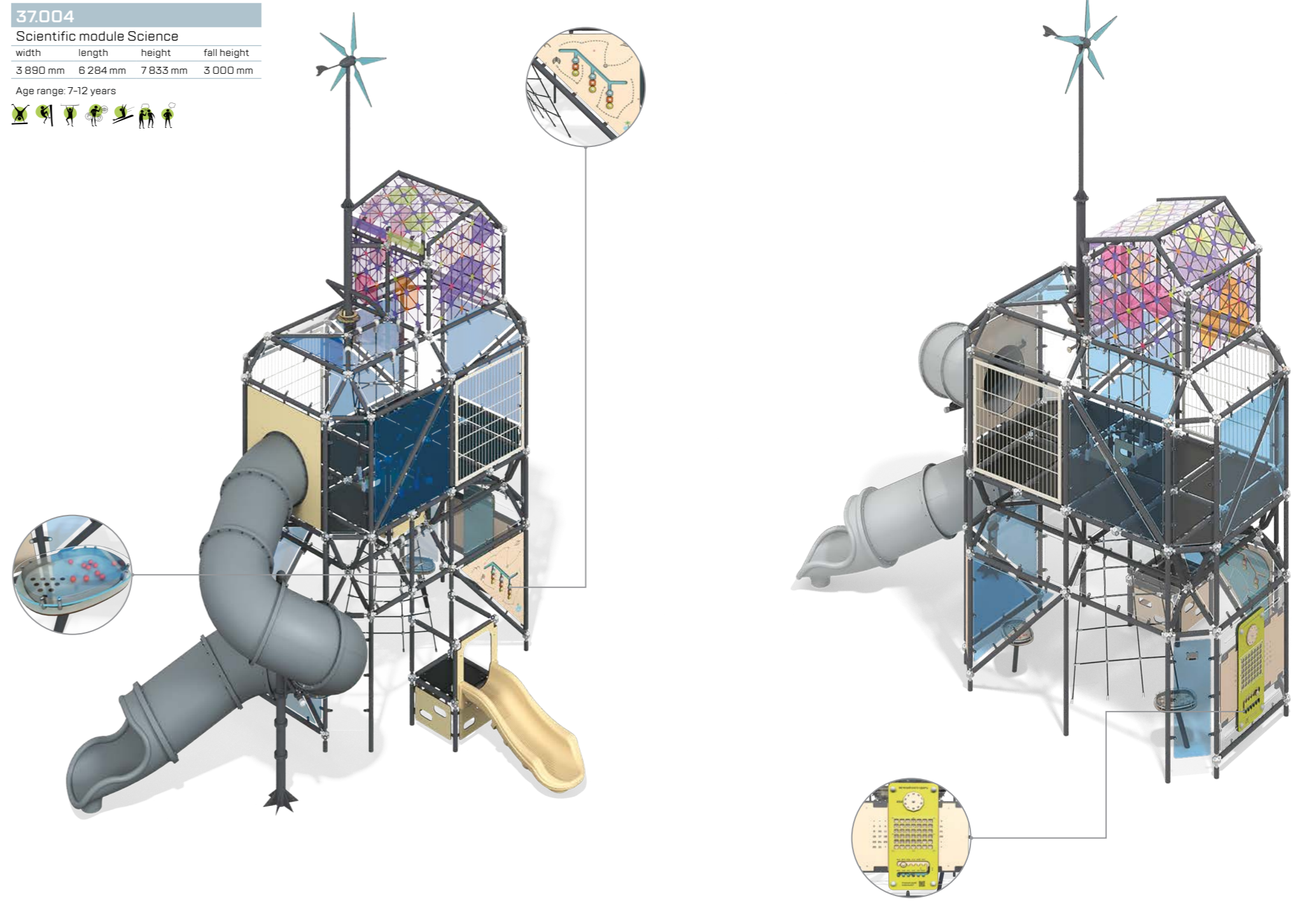



37.001

Scientific module Morse code

width	length	height	fall height
1 326 mm	4 000 mm	1 828 mm	-

Age range: 7-12 years



37.011

Stylophone

width	length	height	fall height
500 mm	587 mm	1 237 mm	-

Age range: 7-12 years

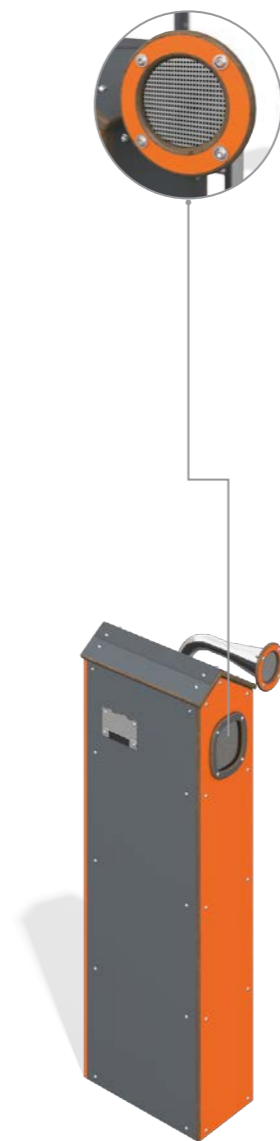

37.006

Scientific module Shadow play

width	length	height	fall height
1 326 mm	2 027 mm	1 854 mm	-

Age range: 7-12 years



37.012

Lightship

width	length	height	fall height
582 mm	611 mm	587 mm	-

Age range: 7-12 years





37.007

Scientific module Electric labyrinth

width	length	height	fall height
750 mm	2 680 mm	1 550 mm	-

Age range: 7-12 years

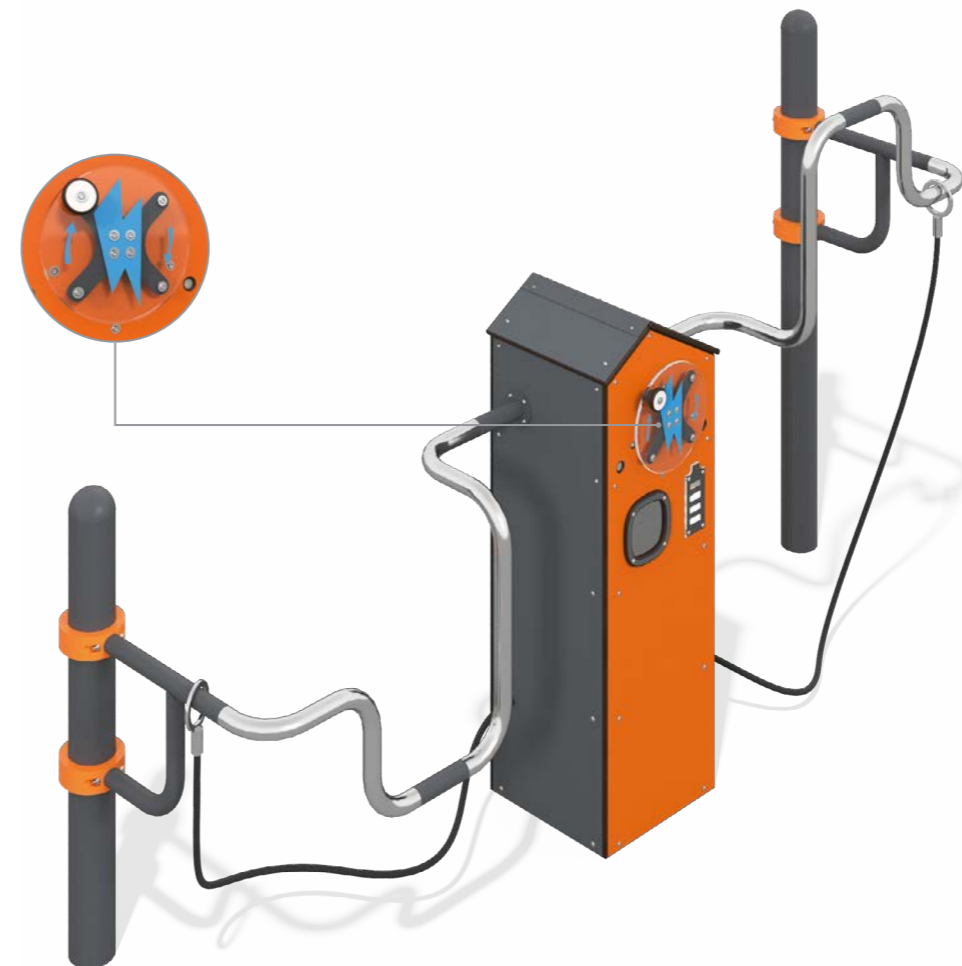

37.002

Scientific module Famous composers

width	length	height	fall height
567 mm	1 507 mm	1 014 mm	-

Age range: 7-12 years

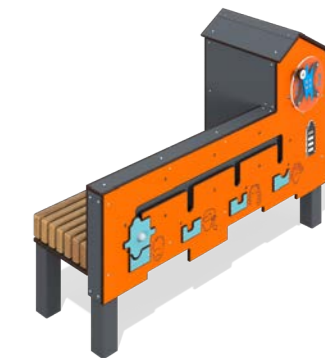

37.008

Scientific module Electrical circuit

width	length	height	fall height
316 mm	1 215 mm	1 500 mm	-

Age range: 7-12 years

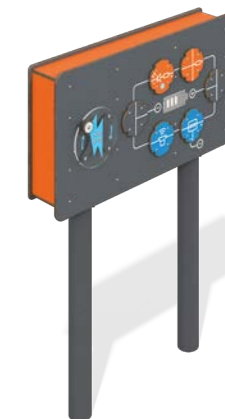

37.003

Scientific module Musical instruments

width	length	height	fall height
567 mm	1 222 mm	1 013 mm	-

Age range: 7-12 years





37.009

Scientific module Cinema

width	length	height	fall height
643 mm	694 mm	1140 mm	-

Age range: 7-12 years



37.010

Coastal Lighthouse

width	length	height	fall height
534 mm	566 mm	1771 mm	-

Age range: 7-12 years

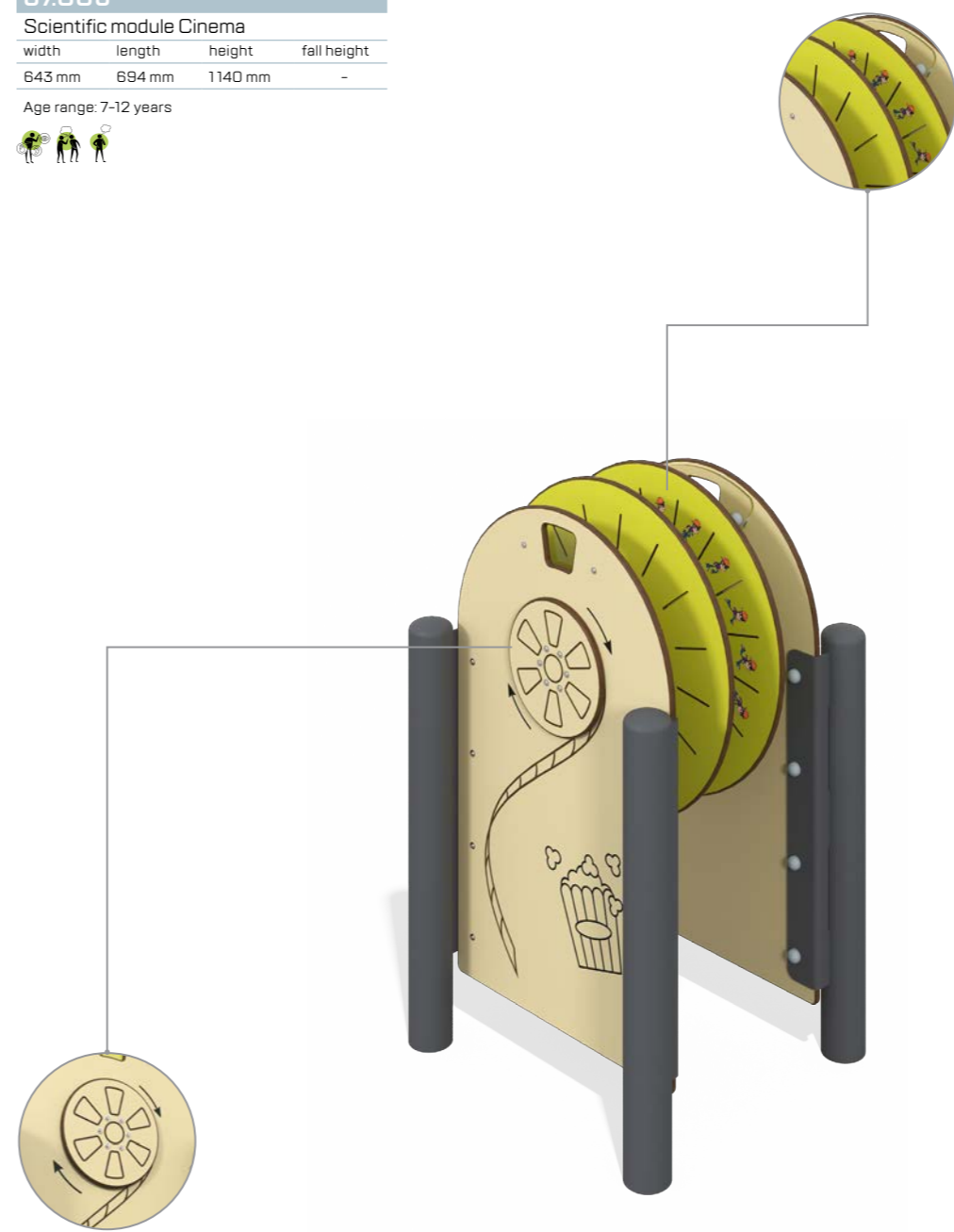

37.005

Scientific module Listen to the city

width	length	height	fall height
1649 mm	2143 mm	4240 mm	-

Age range: 7-12 years





“URBAN” PLAYHUBS



13.183

Play System Thorium

width	length	height	fall height
10 419 mm	12 897 mm	6 023 mm	2 789 mm

Age range: 7-12 years

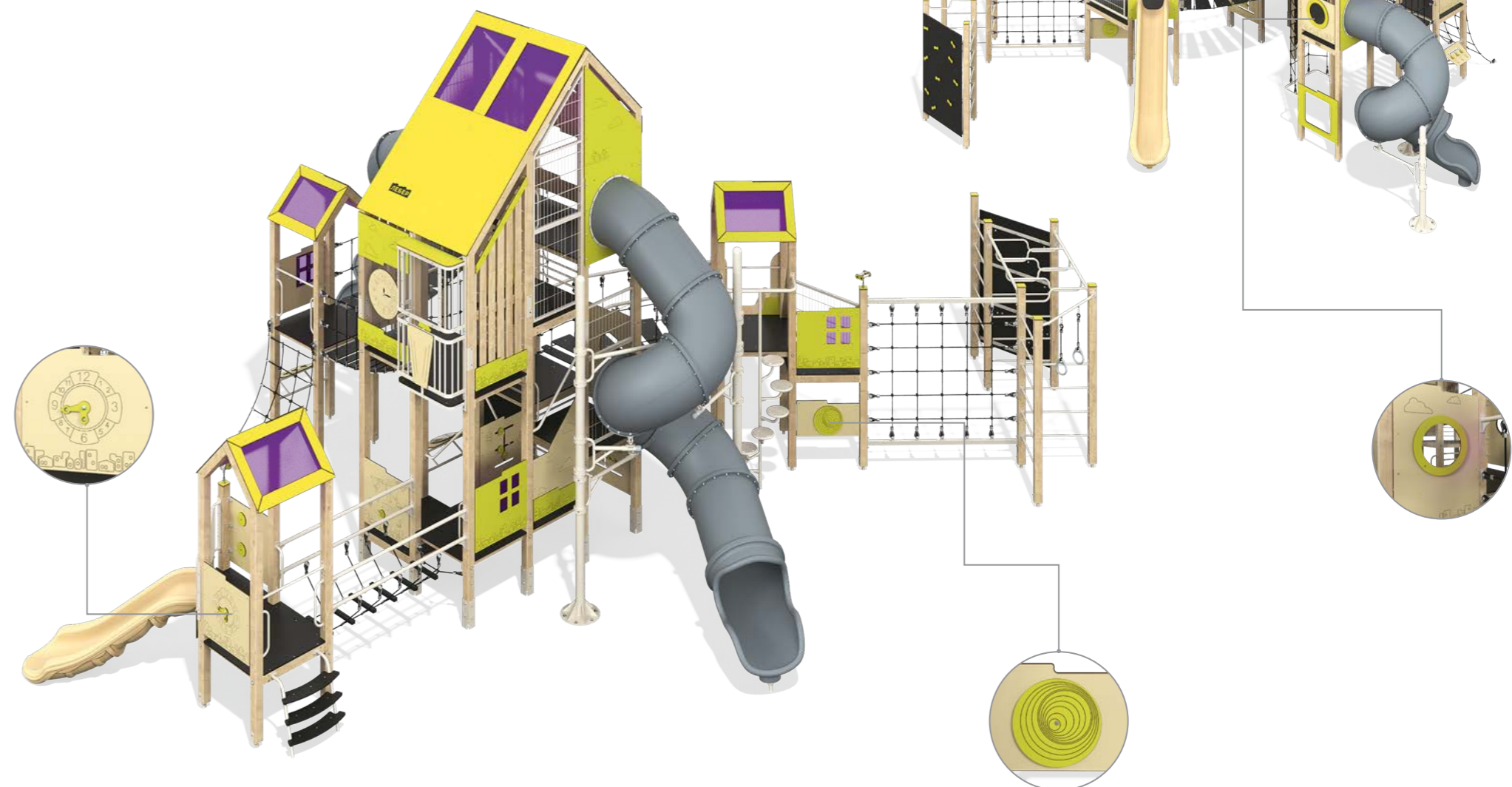



13.191

Play System Technetium

width	length	height	fall height
6 795 mm	10 939 mm	6 005 mm	1 529 mm

Age range: 7-12 years





13.102

Play System Tellurium

width	length	height	fall height
9 523 mm	9 905 mm	5 969 mm	2 251 mm

Age range: 7-12 years

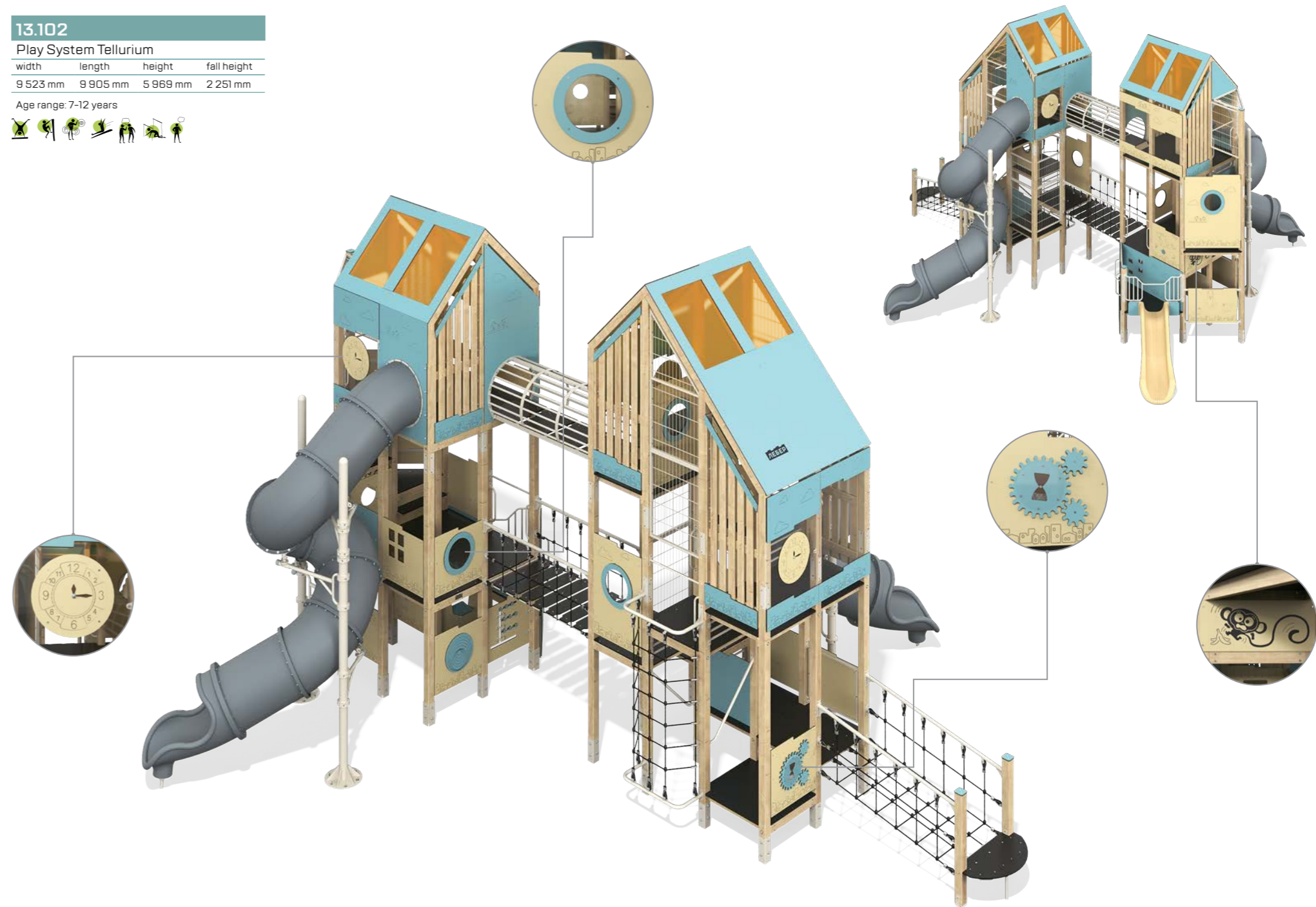



13.186

Play System Strontium

width	length	height	fall height
7 180 mm	14 260 mm	6 010 mm	2 534 mm

Age range: 7-12 years





13.085

Play System Thallium

width	length	height	fall height
8 063 mm	13 192 mm	6 021 mm	2 050 mm

Age range: 7-12 years

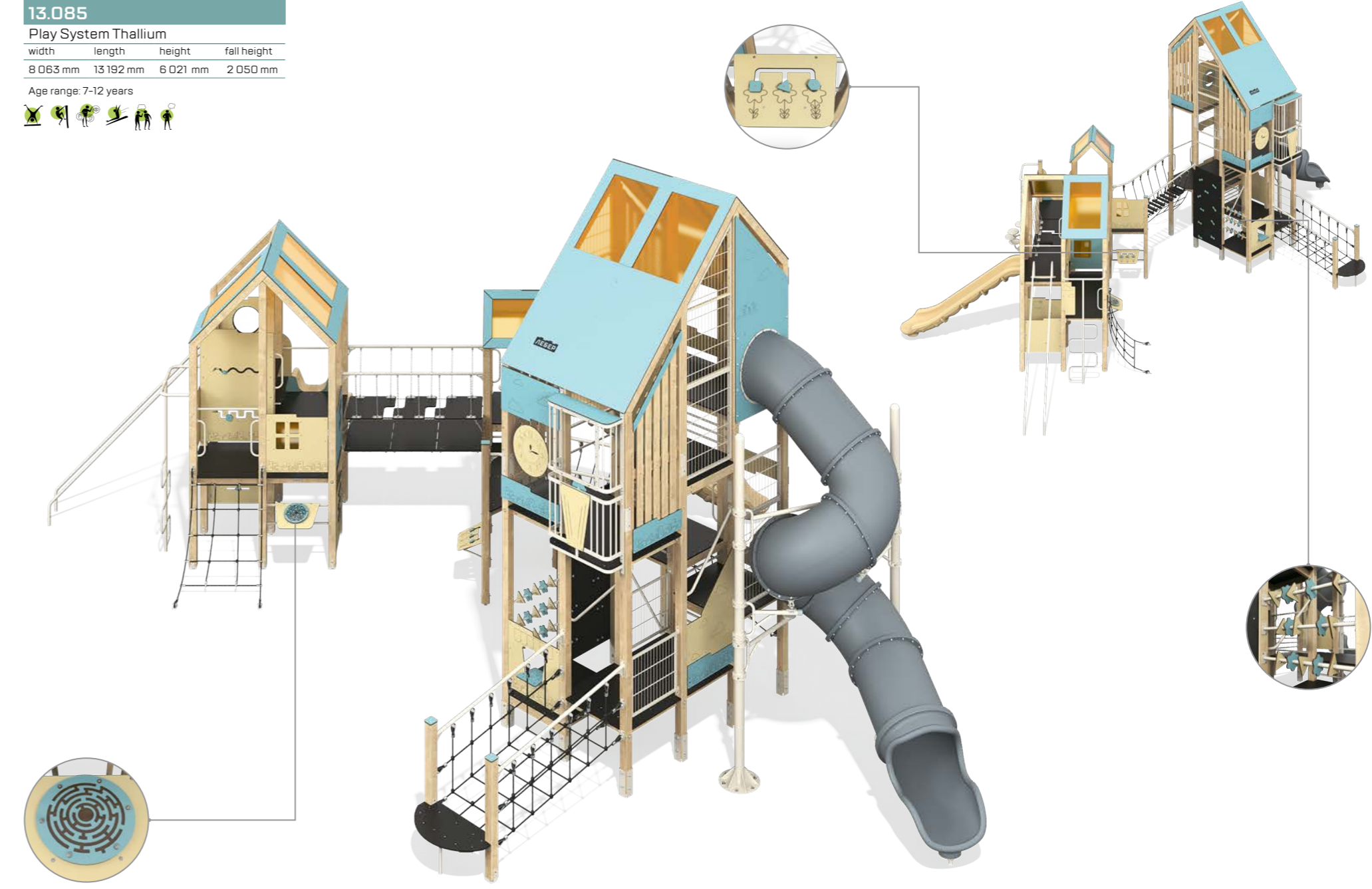



13.185

Play System Radium

width	length	height	fall height
9 982 mm	11 463 mm	3 925 mm	2 036 mm

Age range: 7-12 years

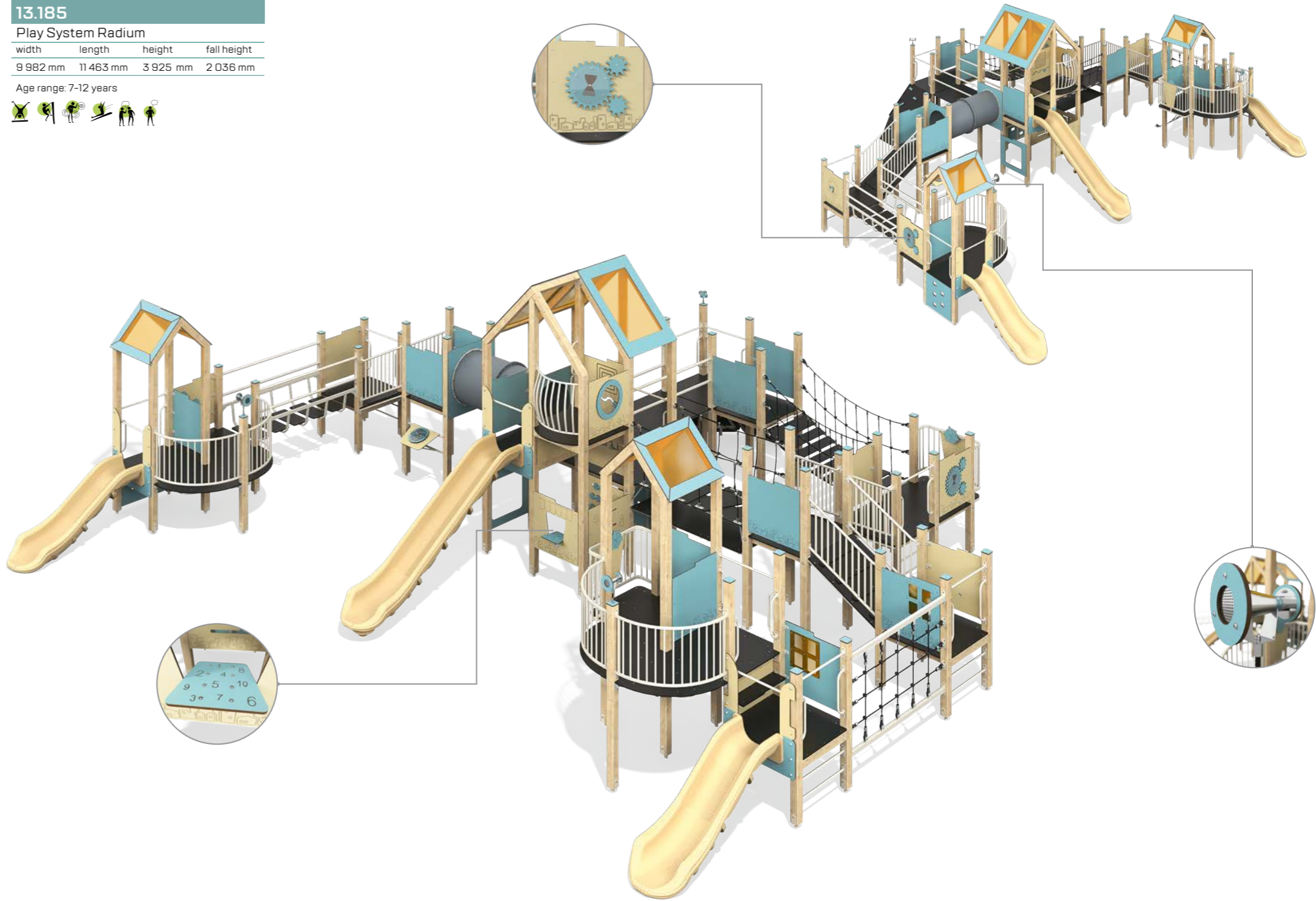



13.184

Play System Cesium

width	length	height	fall height
10 240 mm	13 130 mm	3 925 mm	2 490 mm

Age range: 7-12 years





13.188

Play System Stannum

width	length	height	fall height
8 479 mm	9 056 mm	6 018 mm	2 028 mm

Age range: 7-12 years



13.076

Play System Iridium

width	length	height	fall height
6 427 mm	7 471 mm	6 008 mm	2 528 mm

Age range: 7-12 years

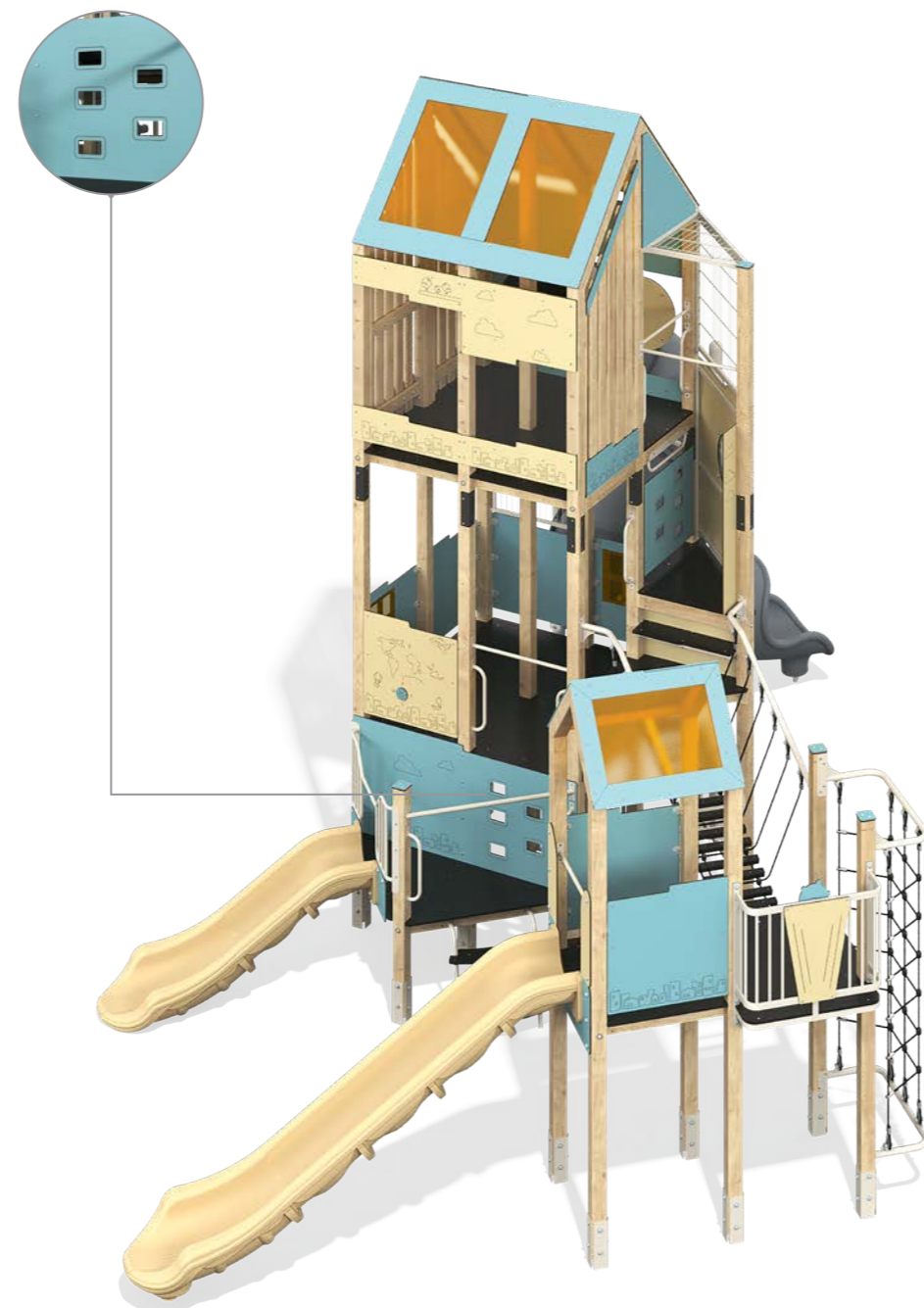

13.074

Play System Barium

width	length	height	fall height
5 016 mm	5 564 mm	6 018 mm	2 028 mm

Age range: 7-12 years

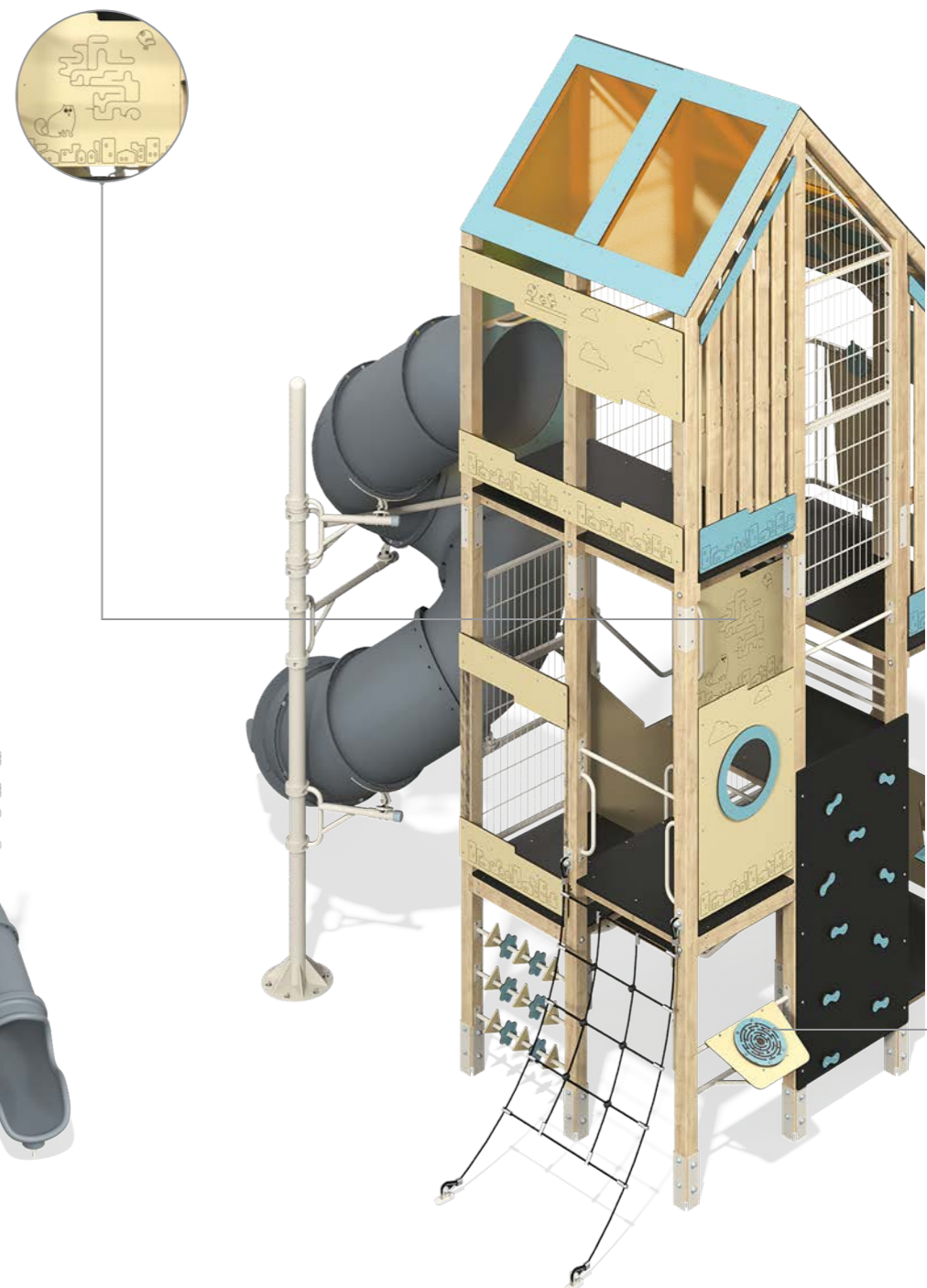
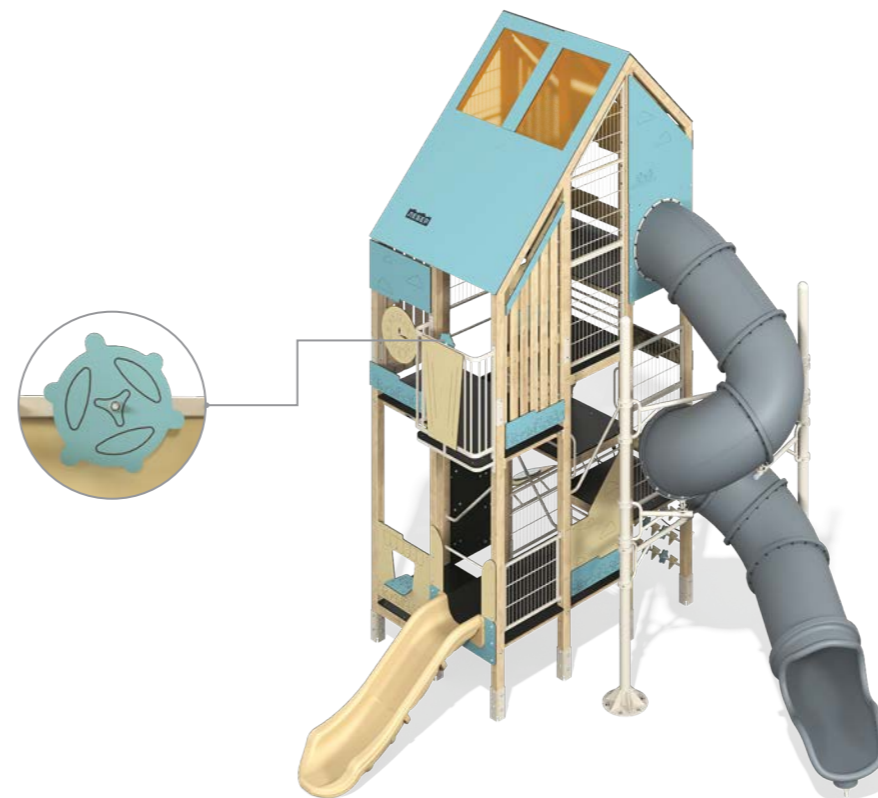



13.072

Play System Beryllium

width	length	height	fall height
8 626 mm	12 106 mm	3 470 mm	1 528 mm

Age range: 7-12 years



13.182

Play System Actinium

width	length	height	fall height
7 705 mm	9 550 mm	2 510 mm	1 560 mm

Age range: 3-7 years

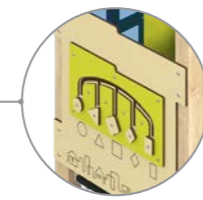

13.036

Play System Normandy

width	length	height	fall height
979 mm	1 002 mm	1 932 mm	250 mm

Age range: 3-7 years

13.127

Play System Silicium

width	length	height	fall height
2 820 mm	4 478 mm	2 347 mm	700 mm

Age range: 3-7 years

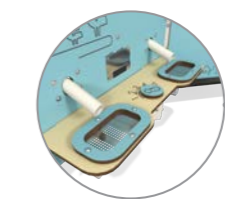

13.013

Play System Tyrol

width	length	height	fall height
1 540 mm	2 395 mm	1 930 mm	250 mm

Age range: 3-7 years



13.194

Play System Rivera

width	length	height	fall height
1 485 mm	1 715 mm	2 060 mm	480 mm

Age range: 3-7 years

13.087

Play System Tantalum

width	length	height	fall height
2 409 mm	4 166 mm	2 899 mm	1 194 mm

Age range: 3-7 years

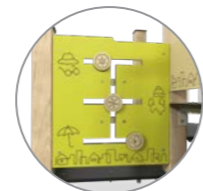

13.143

Play System Glinka

width	length	height	fall height
2 633 mm	3 043 mm	2 337 mm	710 mm

Age range: 3-6 years



13.166

Play System Chaikovsy

width	length	height	fall height
3 131 mm	4 226 mm	2 336 mm	709 mm

Age range: 3-7 years



13.190

Play System Ruthenium

width	length	height	fall height
6 875 mm	7 494 mm	3 368 mm	2 362 mm

Age range: 7-12 years

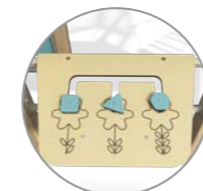
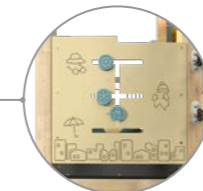
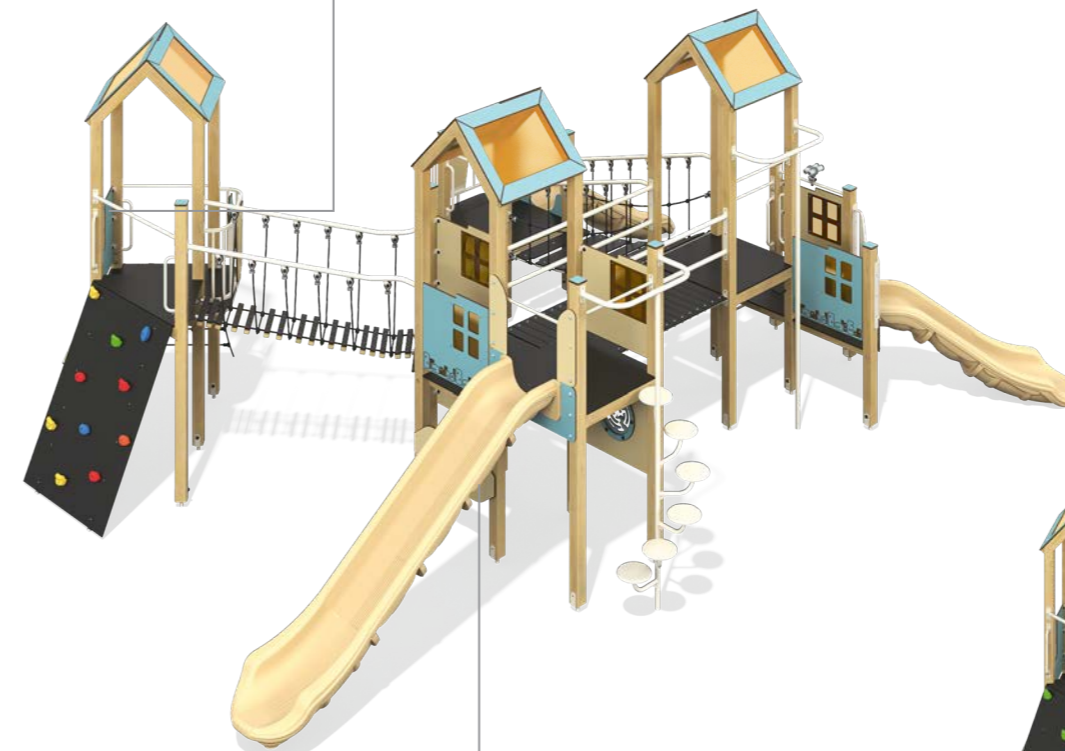

13.189

Play System Argentum

width	length	height	fall height
8 019 mm	10 264 mm	3 969 mm	2 363 mm

Age range: 7-12 years



13.093

Play System Terbium

width	length	height	fall height
4 337 mm	4 747 mm	2 879 mm	1 194 mm

Age range: 3-7 years

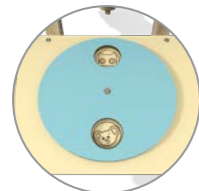

13.181

Play System Rubidium

width	length	height	fall height
3 485 mm	4 100 mm	3 071 mm	1 528 mm

Age range: 7-12 years



13.063

Play System Neptunium

width	length	height	fall height
2 765 mm	3 045 mm	2 365 mm	730 mm

Age range: 3-7 years



13.075

Play System Plutonium

width	length	height	fall height
3 154 mm	4 070 mm	2 349 mm	687 mm

Age range: 3-7 years



13.064

Play System Osmium

width	length	height	fall height
3 113 mm	4 021 mm	2 917 mm	1 939 mm

Age range: 3-7 years

13.176

Play System Ferrum

width	length	height	fall height
1 015 mm	3 316 mm	2 912 mm	1 227 mm

Age range: 3-7 years



13.052

Play System Xenon

width	length	height	fall height
3 580 mm	4 070 mm	2 910 mm	1 230 mm

Age range: 3-7 years



13.022

Play System Alaska

width	length	height	fall height
1 545 mm	1 592 mm	1 932 mm	245 mm

Age range: 3-7 years



13.054

Play System Bismuth

width	length	height	fall height
3 762 mm	3 887 mm	3 035 mm	1 200 mm

Age range: 3-7 years

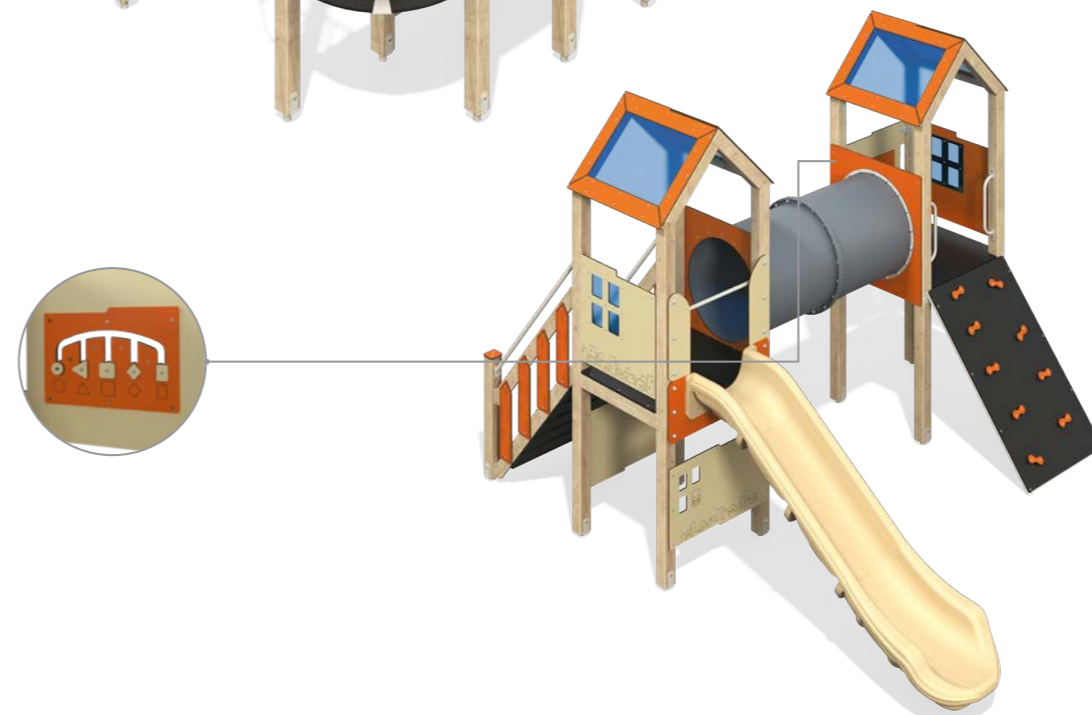

13.039

Play System Rhenium

width	length	height	fall height
3 748 mm	5 492 mm	2 984 mm	2 203 mm

Age range: 3-7 years

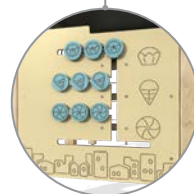

13.203

Play System Rachmaninov

width	length	height	fall height
3 333 mm	4 035 mm	3 007 mm	1 449 mm

Age range: 7-12 years



13.201

Play System Trion

width	length	height	fall height
4 897 mm	4 995 mm	2 563 mm	-

Age range: 3-7 years

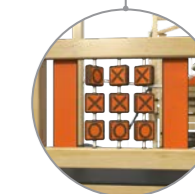

13.044

Play System Niobium

width	length	height	fall height
4 460 mm	4 564 mm	3 172 mm	1 528 mm

Age range: 7-12 years

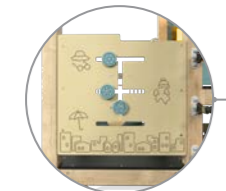

13.195

Play System Tuscany

width	length	height	fall height
2 692 mm	2 917 mm	1 925 mm	245 mm

Age range: 3-7 years



13.126

Play System Francium

width	length	height	fall height
5 690 mm	6 136 mm	3 511 mm	1 574 mm

Age range: 7-12 years

13.193

Play System Lapland

width	length	height	fall height
1 665 mm	1 665 mm	1 902 mm	459 mm

Age range: 2-7 years

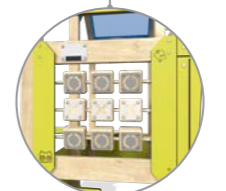

13.010

Play System Santorini

width	length	height	fall height
2 143 mm	2 833 mm	1 895 mm	217 mm

Age range: 3-7 years



13.006

Play System Provence

width	length	height	fall height
1 466 mm	1 963 mm	1 930 mm	580 mm

Age range: 2-7 years



13.053

Play System Lanthanum

width	length	height	fall height
1 635 mm	2 720 mm	2 879 mm	1 194 mm

Age range: 3-7 years



13.038

Play System Aurum

width	length	height	fall height
3 840 mm	5 922 mm	2 917 mm	1 232 mm

Age range: 3-7 years



13.180

Play System Cadmium

width	length	height	fall height
2 917 mm	4 289 mm	2 349 mm	709 mm

Age range: 3-7 years



13.178

Play System Selenium

width	length	height	fall height
2 546 mm	3 457 mm	2 850 mm	1 845 mm

Age range: 3-7 years

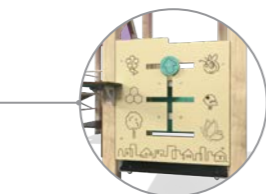
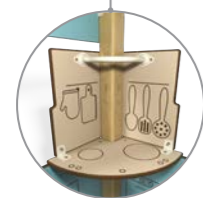

13.202

Play System Erbium

width	length	height	fall height
3 825 mm	3 065 mm	2 932 mm	1 913 mm

Age range: 3-7 years



13.177

Play System Astatium

width	length	height	fall height
2 623 mm	4 142 mm	2 939 mm	1 232 mm

Age range: 3-7 years



13.179

Play System Krypton

width	length	height	fall height
2 916 mm	3 765 mm	2 879 mm	1 194 mm

Age range: 3-7 years



13.200

Play System Neon

width	length	height	fall height
3 311 mm	4 218 mm	2 360 mm	2 287 mm

Age range: 7-12 years

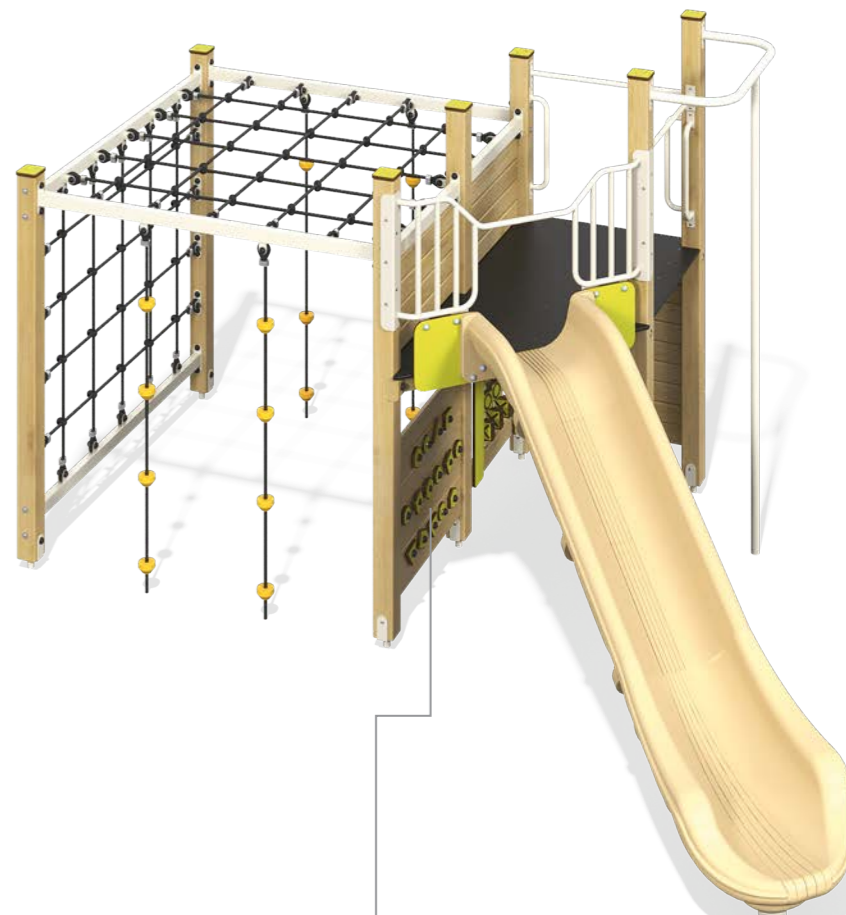



GW-05701

Eco-wood Series Outdoor Playground

width	length	height	fall height
2 900 mm	5 800 mm	3 500 mm	900 mm

Age range: 2-12 years





GW-05601

Eco-wood Series Outdoor Playground

width	length	height
4 000 mm	4 500 mm	3 800 mm

Age range: 2-12 years

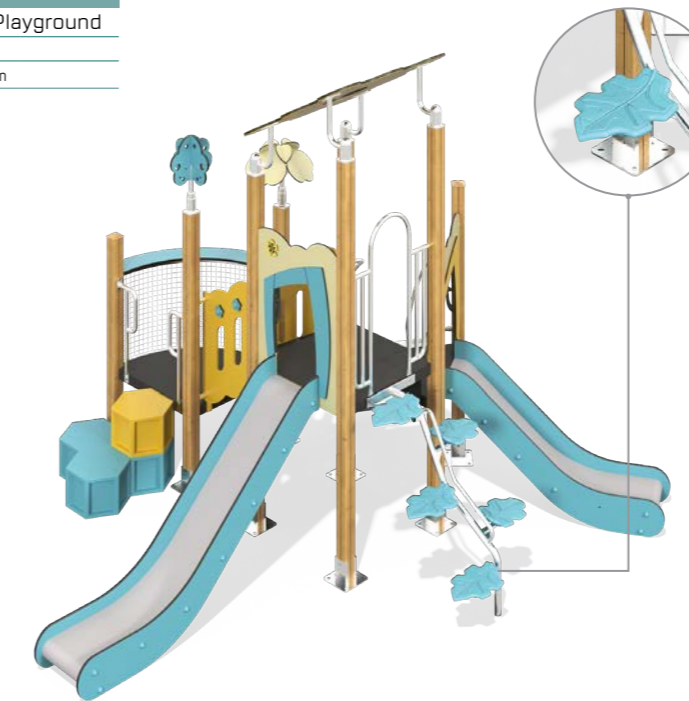

GW-06002

Eco-wood Series Outdoor Playground

width	length	height
2 700 mm	3 800 mm	3 500 mm

Age range: 2-12 years



GW-05903

Eco-wood Series Outdoor Playground

width	length	height
3 100 mm	3 500 mm	3 500 mm

Age range: 2-12 years



GW-05801

Eco-wood Series Outdoor Playground

width	length	height
2 700 mm	5 700 mm	3 800 mm

Age range: 2-12 years



13.007

Play System Balance

width	length	height	fall height
770 mm	1450 mm	1065 mm	230 mm

Age range: 3-7 years



13.009

Play System Pontoon

width	length	height	fall height
770 mm	1450 mm	1065 mm	305 mm

Age range: 3-7 years



23.011

Play System Bridge

width	length	height	fall height
770 mm	1340 mm	1167 mm	455 mm

Age range: 3-7 years



30.008

Climbing wall

width	length	height	fall height
850 mm	1855 mm	1624 mm	1287 mm

Age range: 3-7 years



13.198

Play System Cable bridge

width	length	height	fall height
770 mm	1450 mm	1118 mm	685 mm

Age range: 3-7 years



13.199

Play System Tunnel

width	length	height	fall height
1000 mm	1655 mm	1315 mm	390 mm

Age range: 3-12 years

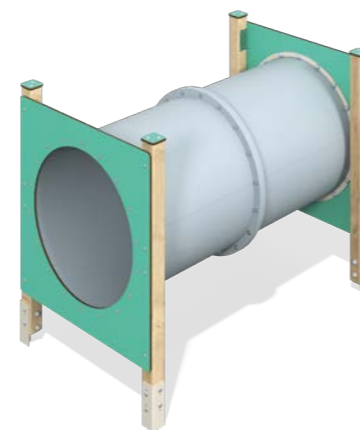

30.036

Labyrinth Hexagon

width	length	height	fall height
1200 mm	4200 mm	900 mm	-

Age range: 3-12 years

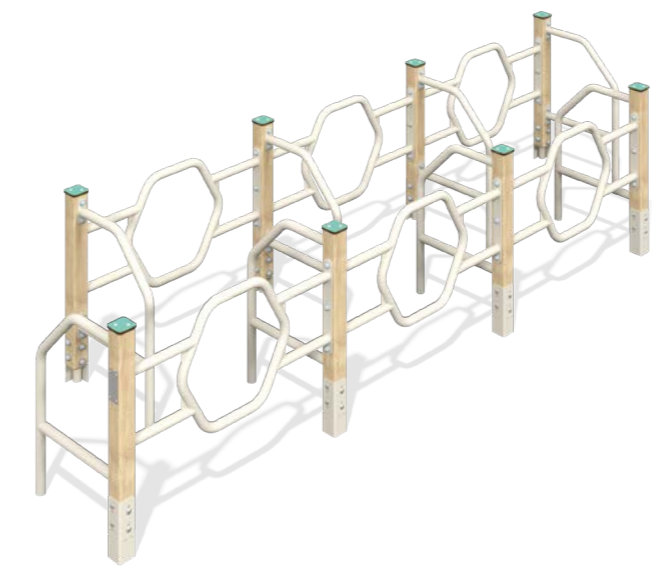

30.035

Labyrinth Geometry

width	length	height	fall height
1200 mm	3610 mm	900 mm	-

Age range: 3-12 years



23.010

Play System Small bridge

width	length	height	fall height
800 mm	2085 mm	900 mm	900 mm

Age range: 3-6 years



30.006

Wooden curved log

width	length	height	fall height
2300 mm	2880 mm	500 mm	500 mm

Age range: 7-12 years





“BRIUM” PLAYHUBS

13.564

Play System Brium

width	length	height	fall height
2 060 mm	3 015 mm	2 815 mm	950 mm

Age range: 3-6 years

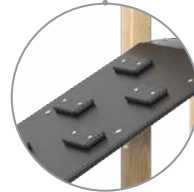

13.571

Play System Brium

width	length	height	fall height
1 700 mm	2 785 mm	2 370 mm	550 mm

Age range: 0-2 years



13.562

Play System Brium

width	length	height	fall height
2 025 mm	2 840 mm	2 815 mm	950 mm

Age range: 3-6 years



13.563

Play System Brium

width	length	height	fall height
2 115 mm	2 845 mm	2 815 mm	950 mm

Age range: 3-6 years



13.561

Play System Brium

width	length	height	fall height
2 840 mm	2 965 mm	2 815 mm	1 630 mm

Age range: 3-6 years



13.569

Play System Brium

width	length	height	fall height
2 015 mm	2 365 mm	2 370 mm	550 mm

Age range: 0-2 years

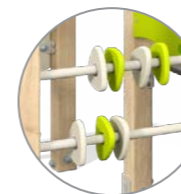

13.346

Play System Brium

width	length	height	fall height
892 mm	1 040 mm	1 922 mm	290 mm

Age range: 0-2 years



13.559

Play System Brium

width	length	height	fall height
2 580 mm	3 285 mm	2 815 mm	1 935 mm

Age range: 3-6 years



13.565

Play System Brium

width	length	height	fall height
1 890 mm	3 180 mm	2 815 mm	950 mm

Age range: 3-6 years



13.568

Play System Brium

width	length	height	fall height
2 040 mm	2 390 mm	2 370 mm	550 mm

Age range: 0-2 years



13.566

Play System Brium

width	length	height	fall height
1 045 mm	2 250 mm	2 370 mm	550 mm

Age range: 0-2 years



19.125

Sandpit Brium

width	length	height	fall height
1 550 mm	1 730 mm	400 mm	400 mm

Age range: 3-7 years



16.132

Spring Rider Brium

width	length	height	fall height
388 mm	665 mm	861 mm	502 mm

Age range: 3-7 years



13.567

Play System Brium

width	length	height	fall height
2 265 mm	2 835 mm	2 370 mm	550 mm

Age range: 0-2 years



"ANTARCTIC" PLAYHUBS



13.533

Play System Antarctic

width	length	height	fall height
4 232 mm	4 637 mm	2 866 mm	1 230 mm

Age range: 3-6 years



13.534

Play System Antarctic

width	length	height	fall height
1 915 mm	2 350 mm	2 464 mm	548 mm

Age range: 0-2 years



13.531

Play System Antarctic

width	length	height	fall height
1 869 mm	4 637 mm	2 866 mm	950 mm

Age range: 3-6 years



13.532

Play System Antarctic

width	length	height	fall height
1 432 mm	2 289 mm	2 866 mm	950 mm

Age range: 3-6 years



19.121

Sandpit Antarctic

width	length	height	fall height
1 465 mm	1 490 mm	260 mm	260 mm

Age range: 3-6 years



16.126

Spring Rider Antarctica

width	length	height	fall height
388 mm	636 mm	934 mm	502 mm

Age range: 3-7 years

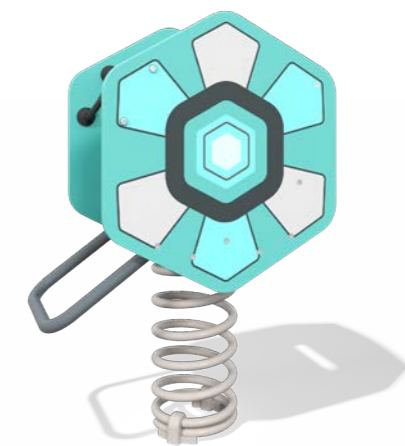



“FORMIX” PLAYHUBS

13.539

Play System Formix

width	length	height	fall height
4 010 mm	5 146 mm	3 115 mm	1 470 mm

Age range: 3-6 years



13.535

Play System Formix

width	length	height	fall height
3 172 mm	5 641 mm	3 115 mm	1 800 mm

Age range: 3-6 years



13.538

Play System Formix

width	length	height	fall height
2 668 mm	3 906 mm	3 115 mm	1 470 mm

Age range: 3-6 years



13.546

Play System Formix

width	length	height	fall height
2 147 mm	2 331 mm	2 465 mm	800 mm

Age range: 0-2 years



13.536

Play System Formix

width	length	height	fall height
2 771 mm	3 323 mm	2 865 mm	1 400 mm

Age range: 3-6 years



13.537

Play System Formix

width	length	height	fall height
4 332 mm	4 481 mm	2 965 mm	2 000 mm

Age range: 3-6 years



13.548

Play System Formix

width	length	height	fall height
2 147 mm	2 693 mm	2 465 mm	800 mm

Age range: 0-2 years



16.098

Spring Rider Formix

width	length	height	fall height
388 mm	678 mm	946 mm	557 mm

Age range: 3-7 years



19.122

Sandpit Formix

width	length	height	fall height
1 520 mm	1 520 mm	300 mm	300 mm

Age range: 3-6 years

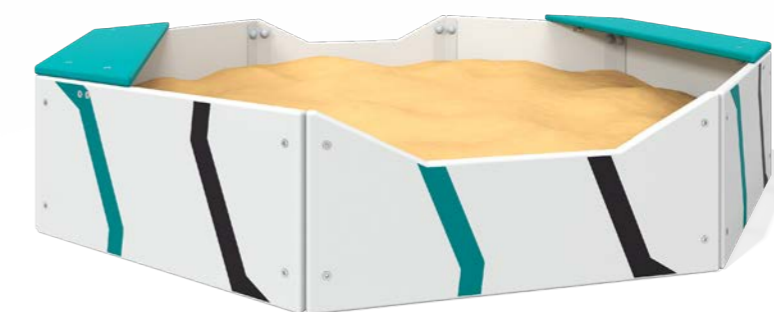

13.543

Play System Formix

width	length	height	fall height
2 197 mm	2 887 mm	2 665 mm	1 000 mm

Age range: 3-6 years



13.545

Play System Formix

width	length	height	fall height
1 557 mm	2 577 mm	2 465 mm	800 mm

Age range: 2-6 years



13.547

Play System Formix

width	length	height	fall height
1 543 mm	2 147 mm	2 465 mm	800 mm

Age range: 0-2 years



13.544

Play System Formix

width	length	height	fall height
1 137 mm	2 147 mm	2 365 mm	800 mm

Age range: 0-2 years



13.541

Play System Formix

width	length	height	fall height
3 091 mm	3 906 mm	3 115 mm	1 470 mm

Age range: 2-6 years



13.542

Play System Formix

width	length	height	fall height
2 985 mm	3 906 mm	3 215 mm	2 000 mm

Age range: 3-6 years





“REULEAUX” PLAYHUBS

13.603**Play System Reuleaux**

width	length	height	fall height
2 042 mm	2 837 mm	2 249 mm	550 mm

Age range: 0-2 years

**13.596****Play System Reuleaux**

width	length	height	fall height
2 570 mm	4 500 mm	2 940 mm	1 200 mm

Age range: 3-6 years

**19.152****Sandpit Reuleaux**

width	length	height	fall height
2 053 mm	2 112 mm	268 mm	-

Age range: 3-6 years

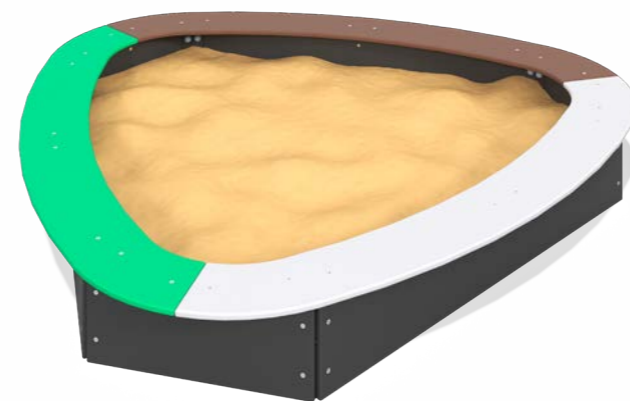
**16.123****Spring Rider Reuleaux**

width	length	height	fall height
388 mm	677 mm	1 009 mm	503 mm

Age range: 3-7 years

**13.601****Play System Reuleaux**

width	length	height	fall height
2 858 mm	3 125 mm	2 965 mm	1 200 mm

Age range: 3-6 years

**13.593****Play System Reuleaux**

width	length	height	fall height
2 190 mm	3 390 mm	2 960 mm	1 200 mm

Age range: 3-6 years

**13.595****Spring Rider Reuleaux**

width	length	height	fall height
4 080 mm	6 240 mm	2 960 mm	1 200 mm

Age range: 3-6 years



13.594

Play System Reuleaux

width	length	height	fall height
2 670 mm	5 110 mm	2 760 mm	1 150 mm

Age range: 3-6 years



13.597

Play System Reuleaux

width	length	height	fall height
3 205 mm	3 734 mm	2 965 mm	1 200 mm

Age range: 3-6 years



13.604

Play System Reuleaux

width	length	height	fall height
2 020 mm	2 177 mm	2 365 mm	550 mm

Age range: 0-2 years



13.598

Play System Reuleaux

width	length	height	fall height
2 670 mm	3 895 mm	2 965 mm	1 200 mm

Age range: 3-6 years



13.602

Spring Rider Reuleaux

width	length	height	fall height
1 481 mm	2 606 mm	2 365 mm	550 mm

Age range: 0-2 years



13.599

Play System Reuleaux

width	length	height	fall height
2 453 mm	2 727 mm	2 765 mm	950 mm

Age range: 3-6 years



13.605

Play System Reuleaux

width	length	height	fall height
1 420 mm	2 160 mm	2 365 mm	550 mm

Age range: 0-2 years





“MAVERICKS” PLAYHUBS

13.622

Play System Mavericks

width	length	height	fall height
1530 mm	2 810 mm	2 040 mm	935 mm

Age range: 0-2 years



13.558

Play System Mavericks

width	length	height	fall height
1535 mm	3 050 mm	2 190 mm	550 mm

Age range: 0-2 years



13.554

Play System Mavericks

width	length	height	fall height
2 830 mm	2 835 mm	2 985 mm	950 mm

Age range: 3-6 years



13.549

Play System Mavericks

width	length	height	fall height
3 025 mm	3 595 mm	2 985 mm	1 700 mm

Age range: 3-6 years



13.552

Play System Mavericks

width	length	height	fall height
2 240 mm	3 530 mm	2 985 mm	950 mm

Age range: 3-6 years



13.555

Play System Mavericks

width	length	height	fall height
2 105 mm	2 850 mm	2 985 mm	950 mm

Age range: 3-6 years

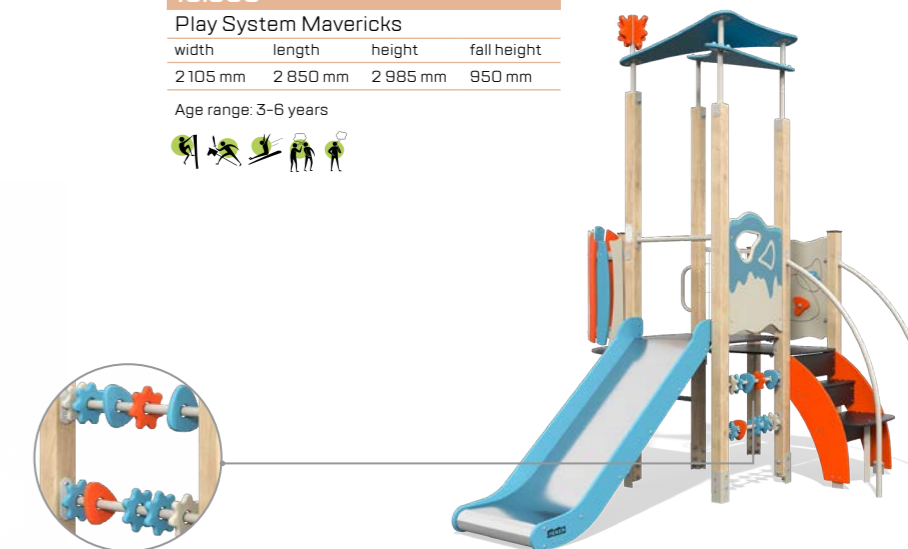

13.551

Play System Mavericks

width	length	height	fall height
2 130 mm	2 875 mm	2 985 mm	950 mm

Age range: 3-6 years



19.123

Sandpit Mavericks

width	length	height	fall height
1 565 mm	1 570 mm	255 mm	-

Age range: 3-6 years



13.553

Play System Mavericks

width	length	height	fall height
2 300 mm	2 840 mm	2 985 mm	1 890 mm

Age range: 3-6 years



13.345

Play System Mavericks

width	length	height	fall height
893 mm	958 mm	2 044 mm	-

Age range: 0-2 years



13.556

Play System Mavericks

width	length	height	fall height
2 150 mm	2 820 mm	2 985 mm	950 mm

Age range: 3-6 years



13.557

Play System Mavericks

width	length	height	fall height
905 mm	2 420 mm	2 190 mm	550 mm

Age range: 0-2 years



16.133

Spring Rider

width	length	height	fall height
388 mm	665 mm	845 mm	502 mm

Age range: 3-7 years

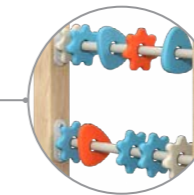



LEBER NATURAL SERIES

MG4051

Play System			
width	length	height	fall height
2 530 mm	6 500 mm	3 470 mm	1 500 mm

Age range: 4-10 years



MG4012

Play System			
width	length	height	fall height
4 760 mm	8 685 mm	4 310 mm	1 630 mm

Age range: 6-12 years



MG4012.1

Play System			
width	length	height	fall height
4 760 mm	8 685 mm	4 615 mm	1 680 mm

Age range: 6-12 years



MG4013.1

Play System			
width	length	height	fall height
8 179 mm	11 367 mm	4 545 mm	1 930 mm

Age range: 6-12 years



MG4003

Play System			
width	length	height	fall height
1 938 mm	3 191 mm	2 263 mm	970 mm

Age range: 3-8 years





MG4020

Play System

width	length	height	fall height
5 447 mm	6 737 mm	3 518 mm	2 418 mm

Age range: 4-10 years

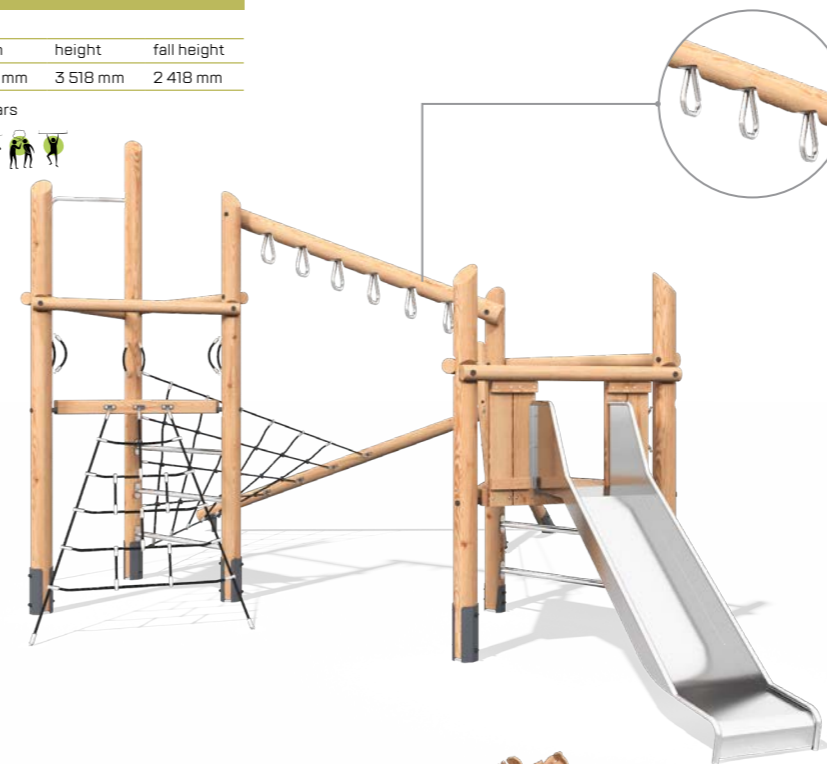

MG3008

Slide with platform

width	length	height	fall height
2 945 mm	3 748 mm	2 755 mm	1 455 mm

Age range: 4-7 years



MG4007

Play System

width	length	height	fall height
4 702 mm	6 559 mm	4 799 mm	1 925 mm

Age range: 6-12 years



MG3007

Slide with platform

width	length	height	fall height
1 762 mm	3 693 mm	2 748 mm	1 455 mm

Age range: 3-7 years



MG1204

Sandpit

width	length	height	fall height
4 328 mm	5 915 mm	2 300 mm	-

Age range: 2+



MG1203.1

Sandpit

width	length	height	fall height
4 400 mm	6 700 mm	2 435 mm	418 mm

Age range: 2+ years



MG1507

House

width	length	height	fall height
2 400 mm	2 571 mm	2 982 mm	1 455 mm

Age range: 7-12 years



MG1504

House

width	length	height	fall height
1 440 mm	1 814 mm	2 455 mm	485 mm

Age range: 1-6 years



MG1501.1

House

width	length	height	fall height
1 480 mm	2 635 mm	2 900 mm	-

Age range: 1-6 years



MG1505

House

width	length	height	fall height
1 520 mm	1 550 mm	2 080 mm	-

Age range: 1-6 years



23.205**Educational Module Drawing board**

width	length	height	fall height
540 mm	2 000 mm	1 900 mm	-

Age range: 2+

**MG2001****Children's table with stumps**

width	length	height	fall height
1 508 mm	1 508 mm	500 mm	500 mm

Age range: 1-6 years

**MG1002****Carousel**

width	length	height	fall height
1 250 mm	1 250 mm	1 428 mm	159 mm

Age range: 3-12 years

**MG1001****Carousel**

width	length	height	fall height
1 276 mm	1 276 mm	1 019 mm	197 mm

Age range: 3-12 years

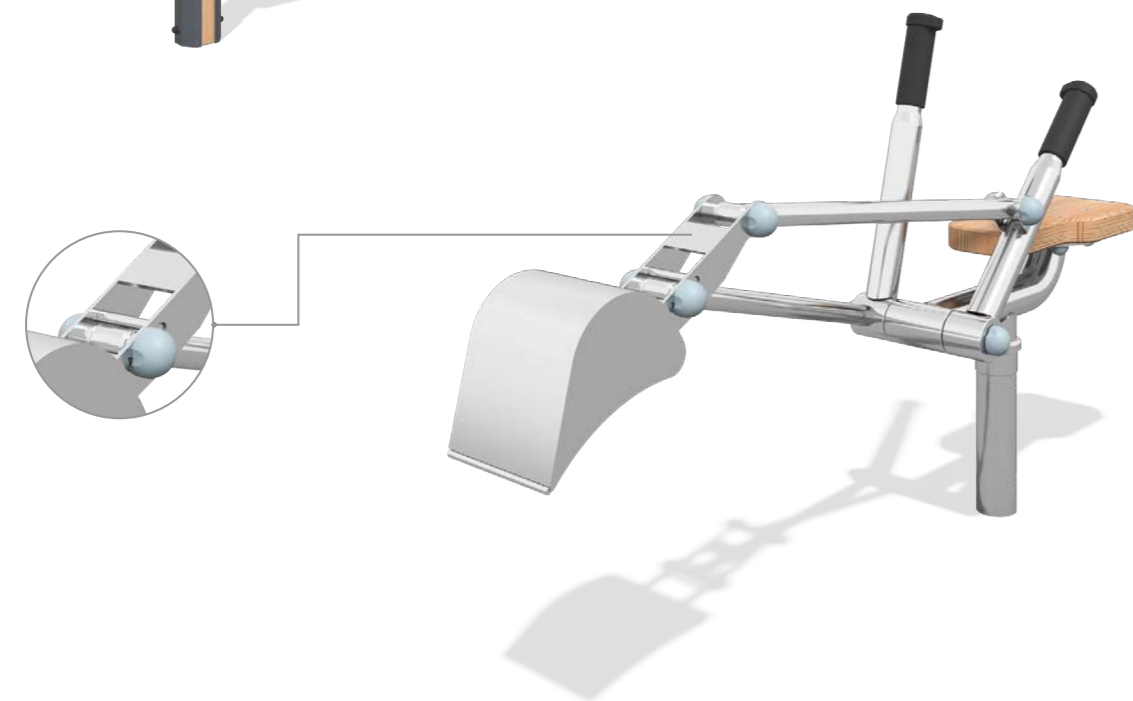
**MG3201****Sand play excavator**

width	length	height	fall height
252 mm	1 240 mm	735 mm	-

Age range: 2-6 years

**MG0208****Spring Riders**

width	length	height	fall height
336 mm	750 mm	807 mm	800 mm

Age range: 3-7 years

**MG1005****Carousel**

width	length	height	fall height
1 418 mm	1 418 mm	802 mm	503 mm

Age range: 3-12 years



MG0002

Seesaw 4-seater

width	length	height	fall height
510 mm	3 750 mm	845 mm	1 065 mm

Age range: 4-12 years

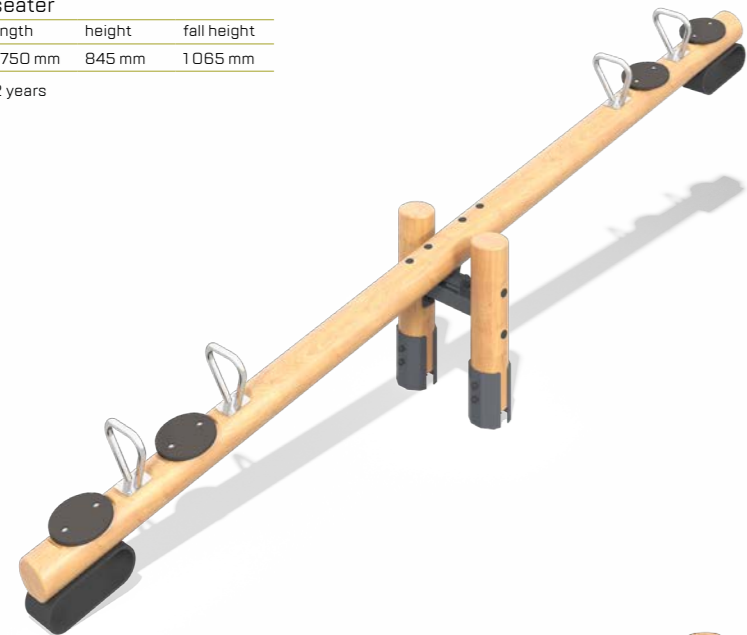

MG0001

Double Seesaw

width	length	height	fall height
525 mm	3 750 mm	900 mm	1 030 mm

Age range: 3-12 years

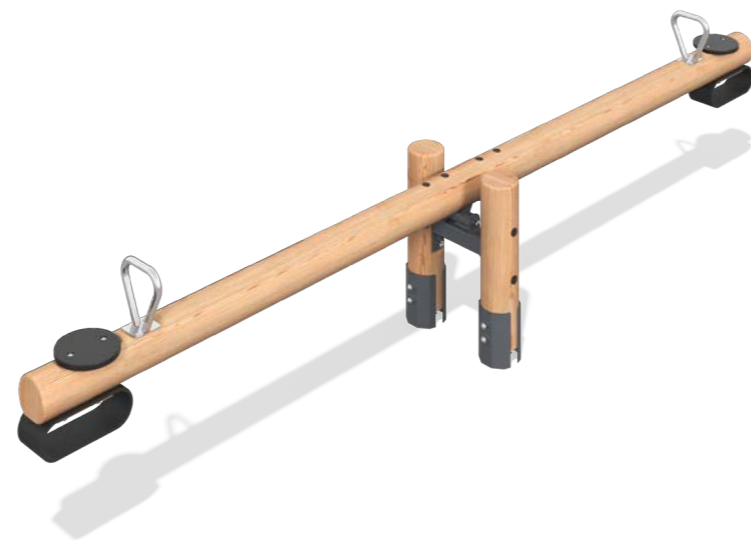

MG0006

Seesaw Taiga

width	length	height	fall height
630 mm	4 000 mm	2 705 mm	1 400 mm

Age range: 7-12 years

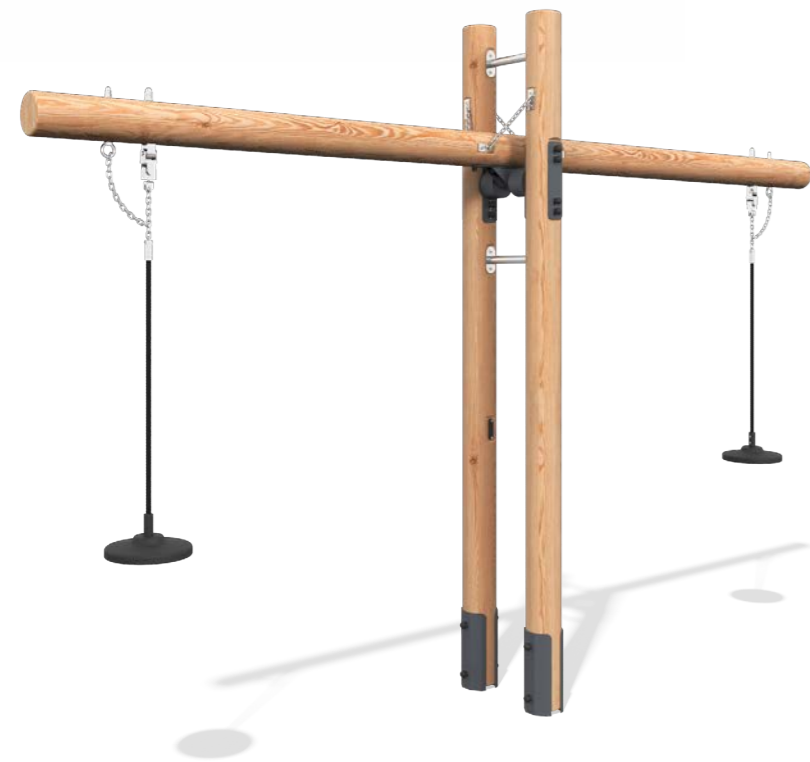

MG0520

Double swing

width	length	height	fall height
2 080 mm	7 230 mm	2 750 mm	1 500 mm

Age range: 3-12 years

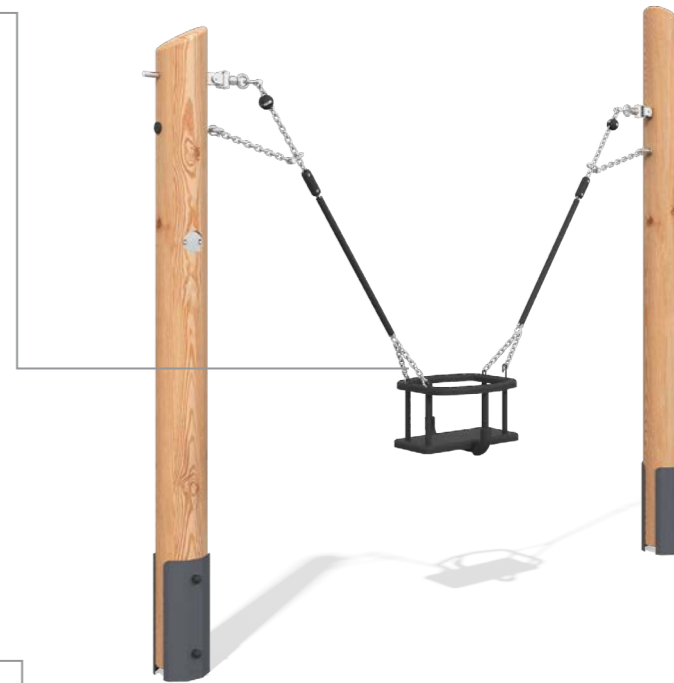

MG0515

Swing

width	length	height	fall height
300 mm	2 050 mm	2 100 mm	-

Age range: 1-3 years

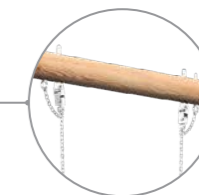

MG3515

Sports equipment Crossing

width	length	height	fall height
848 mm	1158 mm	1109 mm	724 mm

Age range: 3-12 years

**MG3509**

Sports equipment Log

width	length	height	fall height
550 mm	3 500 mm	370 mm	-

Age range: 3-12 years

**11.034**

Seesaw

width	length	height	fall height
240 mm	2 500 mm	800 mm	-

Age range: 3-7 years

**16.073**

Spring Rider

width	length	height	fall height
575 mm	785 mm	780 mm	600 mm

Age range: 3-7 years

**MG3502**

Sports equipment Balance posts

width	length	height	fall height
900 mm	2 070 mm	320 mm	-

Age range: 3-12 years

**MG3523.3**

Sports equipment Log

width	length	height	fall height
260 mm	1 200 mm	240 mm	240 mm

Age range: 3+

**11.035**

Seesaw

width	length	height	fall height
240 mm	1 440 mm	800 mm	-

Age range: 3-7 years

**16.071**

Spring Rider

width	length	height	fall height
230 mm	795 mm	765 mm	-

Age range: 3-7 years



MG3514

Sport equipment Crossing			
width	length	height	fall height
800 mm	1 397 mm	1 090 mm	430 mm

Age range: 3-12 years



MG3519

Sport equipment Crossing			
width	length	height	fall height
382 mm	1 482 mm	2 550 mm	1 615 mm

Age range: 6-12 years



MG3511

Sports equipment Handlebar			
width	length	height	fall height
1 600 mm	2 140 mm	2 000 mm	-

Age range: 14+



MG3531

Sport equipment Triple beam			
width	length	height	fall height
2 190 mm	7 530 mm	610 mm	-

Age range: 3-12 years

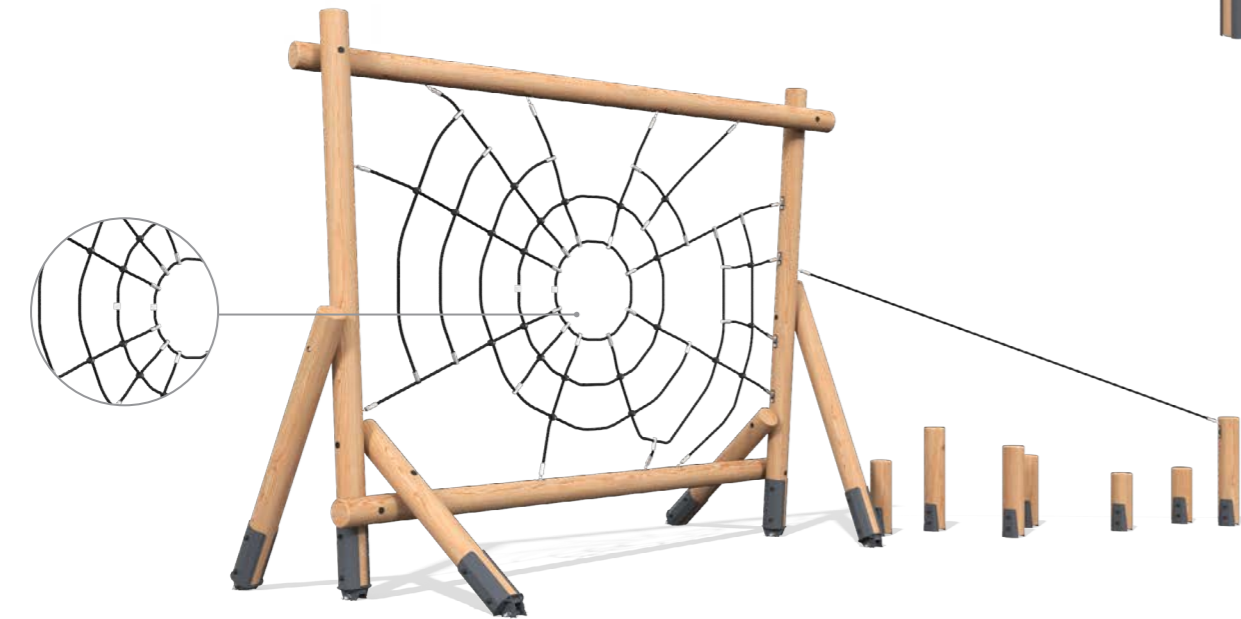

MG3546

Sports equipment Crossing			
width	length	height	fall height
3 563 mm	5 485 mm	2 856 mm	1 716 mm

Age range: 6-12 years

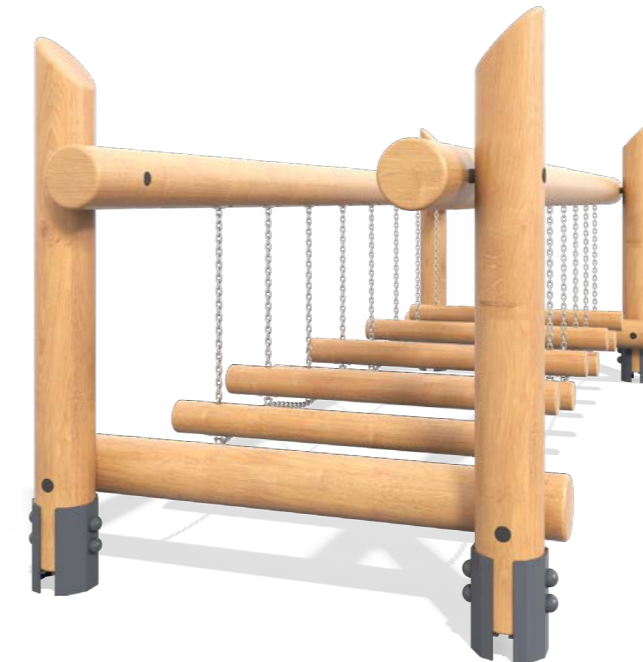

MG3538

Sport equipment			
width	length	height	fall height
1 250 mm	3 800 mm	1 400 mm	400 mm

Age range: 3-12 years



MG4201

Sports system

width	length	height	fall height
3 016 mm	3 397 mm	2 165 mm	2 165 mm

Age range: 6-12 years

**MG4207**

Sports system

width	length	height	fall height
5 344 mm	6 565 mm	2 805 mm	2 565 mm

Age range: 6-12 years

**MG4006**

Play System

width	length	height	fall height
6 259 mm	7 495 mm	4 021 mm	1 938 mm

Age range: 6-12 years

**MG4209**

Sports system

width	length	height	fall height
2 490 mm	2 680 mm	2 600 mm	1 900 mm

Age range: 6-12 years

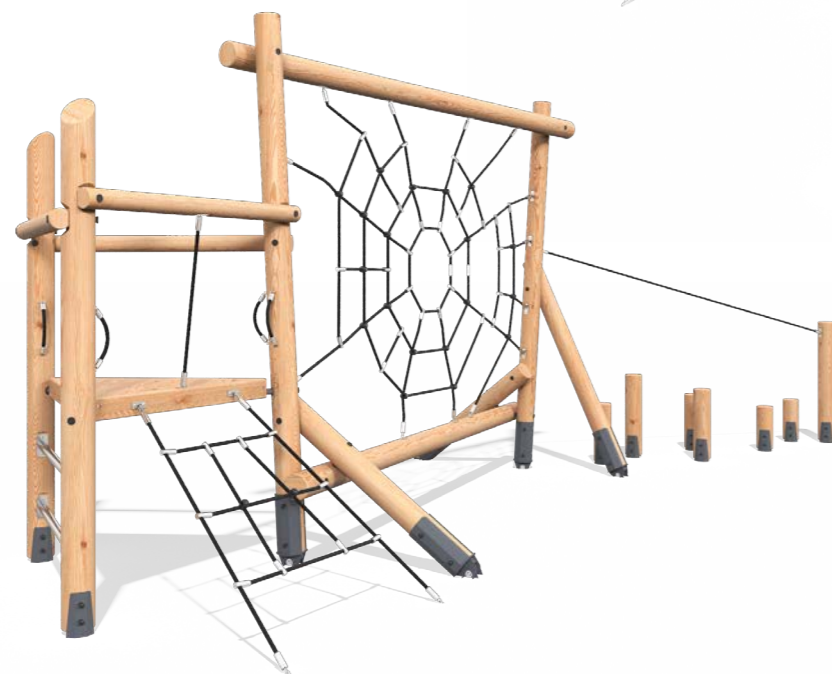
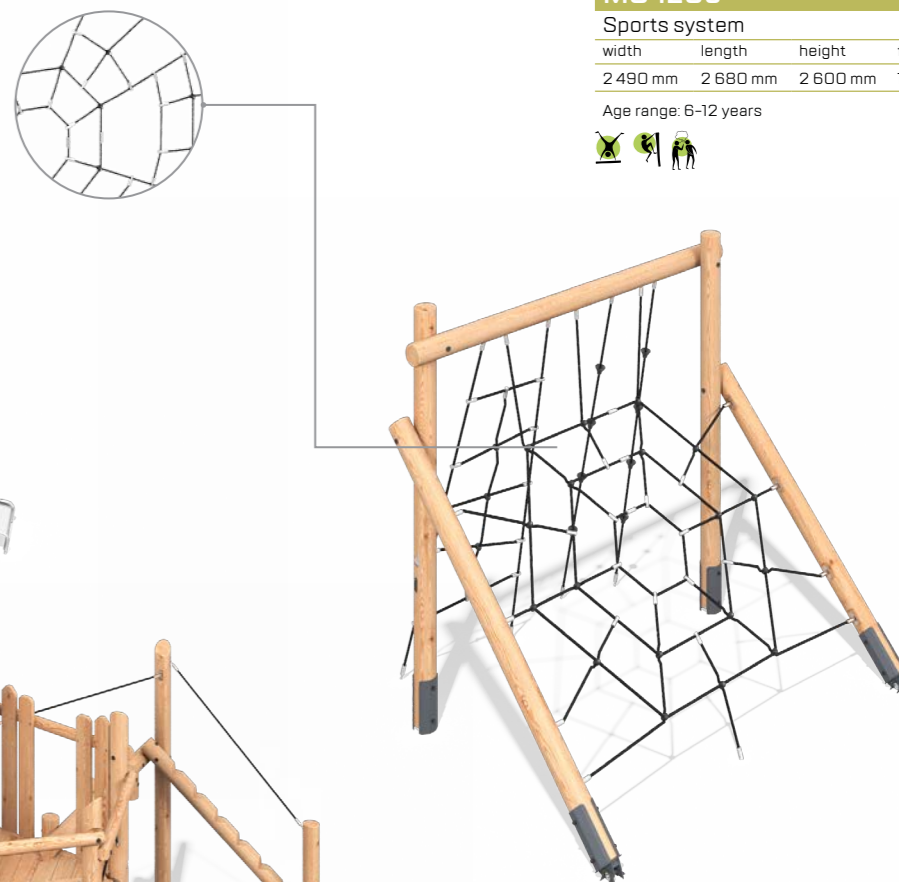
**MG3547**

Web Sports Module

width	length	height	fall height
2 667 mm	7 270 mm	2 851 mm	1 704 mm

Age range: 6-12 years

**MG4014**

Play System

width	length	height	fall height
5 955 mm	7 230 mm	3 125 mm	1 930 mm

Age range: 4-10 years



MG4051-1

Play System			
width	length	height	fall height
2 530 mm	6 500 mm	3 470 mm	1 500 mm

Age range: 4-10 years



MG4003-1

Play System "Hygge"			
width	length	height	fall height
1 938 mm	3 191 mm	2 263 mm	970 mm

Age range: 3-8 years



13.311

Play System "Hygge"			
width	length	height	fall height
5 400 mm	3 500 mm	4 500 mm	-

Age range: 7-14 years

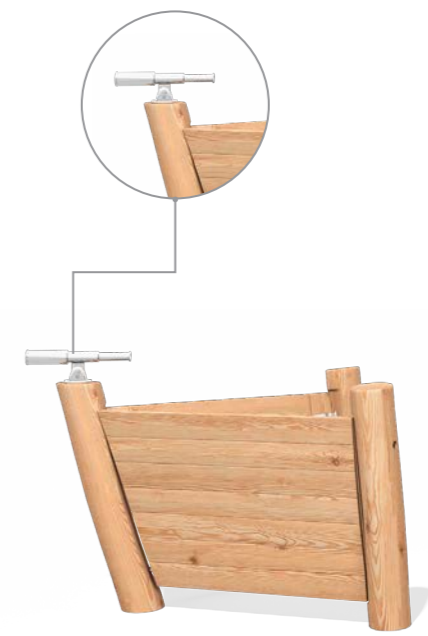

13.701

Play System			
width	length	height	fall height
2 915 mm	3 500 mm	2 675 mm	900 mm

Age range: 3-7 years



At Leber, we recognize that every playground is unique. That's why our slides are designed for ultimate flexibility — allowing you to choose the perfect configuration, material, and placement to match your space and vision.

Material Options:
 Stainless Steel: Durable and sleek, ideal for modern designs. HPL and HDPE Plastic: Materials with exceptional weather resistance and long-lasting aesthetics.

13.315

Play System "Hygge"

width	length	height	fall height
1220 mm	2 950 mm	2 540 mm	900 mm

Age range: 0-3 years



13.308

Play System "Hygge"

width	length	height	fall height
3 465 mm	3 565 mm	3 250 mm	900 mm

Age range: 3-7 years



14.043

Carousel

width	length	height	fall height
1 800 mm	1 800 mm	450 mm	-

Age range: 3-7 years



34.252

Children's park bench

width	length	height	fall height
400 mm	1 170 mm	650 mm	-

Age range: 0-3 years



19.083

Sandpit

width	length	height	fall height
2 100 mm	2 100 mm	350 mm	-

Age range: 0-3 years



21.022

Rope Climbing Playground Ham-
mock on racks made of round timber

width	length	height	fall height
920 mm	4 000 mm	1 750 mm	500 mm

Age range: 7-12 years

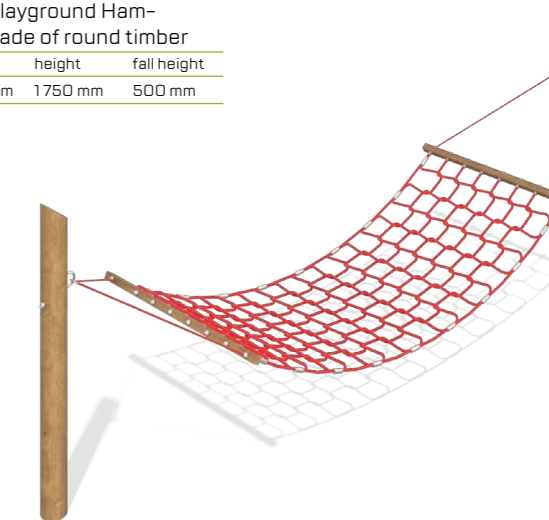

MG3530

Sports equipment Double log

width	length	height	fall height
2 523 mm	5 000 mm	556 mm	-

Age range: 3-12 years

**MG3520**

Sport equipment Crossing

width	length	height	fall height
484 mm	2 248 mm	2 805 mm	-

Age range: 3-12 years

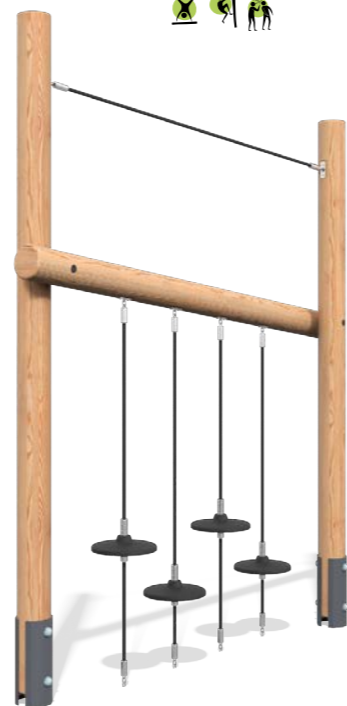
**MG3510**

Sports equipment Jumping ladder

width	length	height	fall height
2 490 mm	3 079 mm	1 055 mm	1 000 mm

Age range: 7-12 years

**17.073**

Swing Nest

width	length	height	fall height
1 200 mm	2 850 mm	2 150 mm	-

Age range: 3-7 years

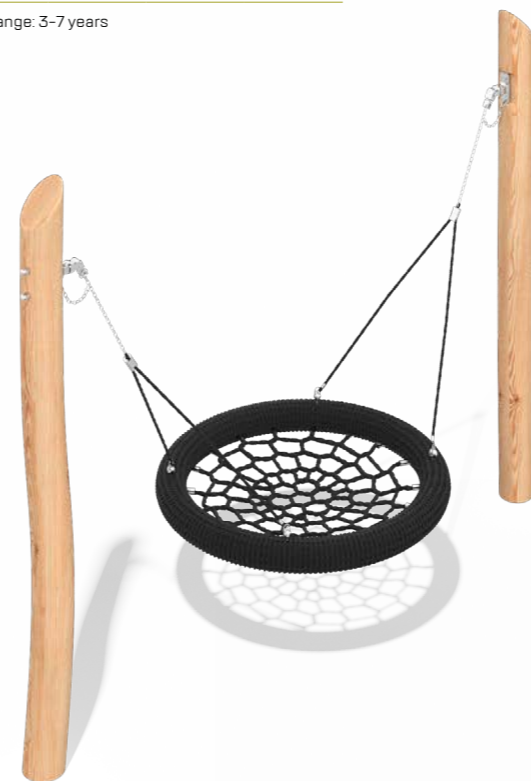
**17.068**

Swing

width	length	height	fall height
200 mm	2 000 mm	2 510 mm	-

Age range: 3-7 years

**MG0502**

Swing

width	length	height	fall height
2 445 mm	2 850 mm	2 590 mm	-

Age range: 3-12 years



MG4009.1-1

Play System

width	length	height	fall height
16 023 mm	18 580 mm	3 875 mm	2 610 mm

Age range: 7-12 years



MG4205

Sports system Nature trail

width	length	height	fall height
7 084 mm	7 760 mm	599 mm	599 mm

Age range: 6-12 years



MG4206

Sports system Nature trail

width	length	height	fall height
7 745 mm	13 643 mm	2 856 mm	1 717 mm

Age range: 6-12 years

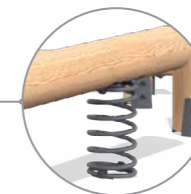

MG4214

Sports system

width	length	height	fall height
6 029 mm	9 081 mm	2 228 mm	1 228 mm

Age range: 7-12 years



MG4009.1

Play System

width	length	height	fall height
16 023 mm	18 580 mm	3 875 mm	2 610 mm

Age range: 7-12 years



MG4009.1-2

Play System

width	length	height	fall height
16 023 mm	18 580 mm	3 875 mm	2 610 mm

Age range: 7-12 years

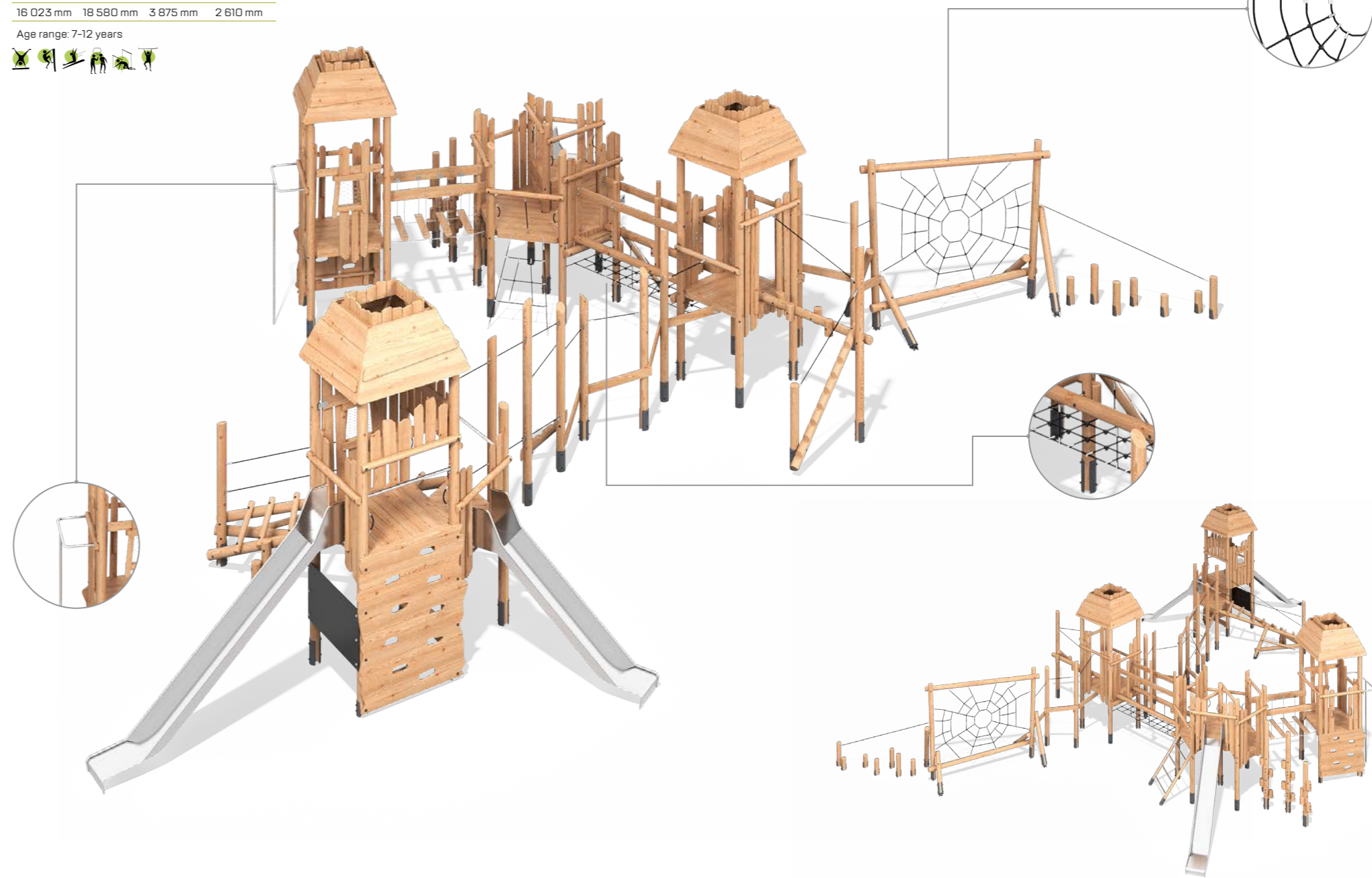



FREESTANDING PLAY EQUIPMENT

17.044

Swing Spiral

width	length	height	fall height
2 942 mm	4 065 mm	2 220 mm	1 400 mm

Age range: 3-12 years

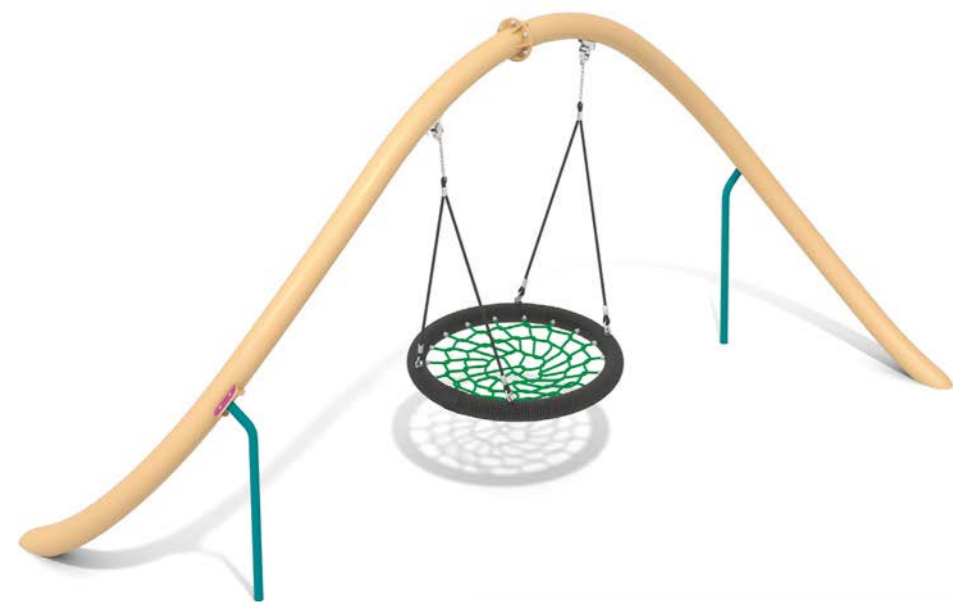

17.048

Swing Amplitude

width	length	height	fall height
1 491 mm	3 465 mm	3 025 mm	1 547 mm

Age range: 3-12 years



17.223

Swing Frame Claws

width	length	height	fall height
1 000 mm	2 860 mm	2 340 mm	1 230 mm

Age range: 3-12 years



17.221

Swing Towers

width	length	height	fall height
5 198 mm	5 458 mm	3 612 mm	1 355 mm

Age range: 3-12 years



17.222

Group Swing

width	length	height	fall height
6 767 mm	6 767 mm	2 617 mm	1 400 mm

Age range: 3-12 years



S-20402

Swing series

width	length	height	fall height
1 200 mm	3 500 mm	2 300 mm	

Age range: 2-12 years

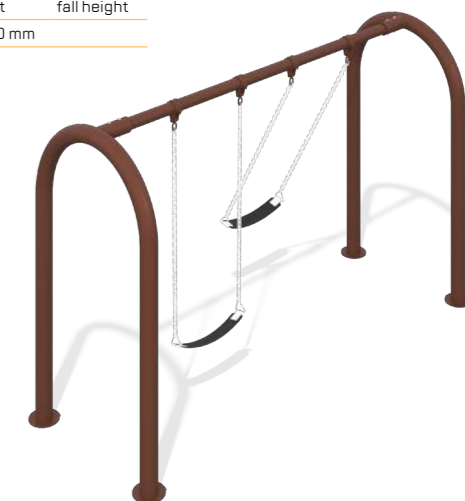



17.227

Wooden double swing Urban

width	length	height	fall height
1500 mm	3390 mm	2126 mm	1200 mm

Age range: 3-12 years



17.235

Wooden single swing

width	length	height	fall height
1500 mm	2390 mm	2150 mm	1300 mm

Age range: 3-12 years



17.229

Wooden swing Nest Urban

width	length	height	fall height
1480 mm	3381 mm	2124 mm	1163 mm

Age range: 3-12 years



17.213

Triple metal swing Nest

width	length	height	fall height
1460 mm	8 755 mm	2 640 mm	1400 mm

Age range: 3-12 years



17.211

Double metal swing Nest

width	length	height	fall height
1460 mm	5 870 mm	2 640 mm	1400 mm

Age range: 3-12 years



17.216

Double metal swing

width	length	height	fall height
1460 mm	3 495 mm	2 640 mm	1450 mm

Age range: 3-12 years



17.215

Three-section metal swing

width	length	height	fall height
1460 mm	9 470 mm	2 640 mm	1370 mm

Age range: 3-12 years



17.212

Double metal swing

width	length	height	fall height
1460 mm	3 695 mm	2 640 mm	1400 mm

Age range: 3-12 years





17.047

Swing Portal

width	length	height	fall height
1 372 mm	5 939 mm	2 651 mm	1 500 mm

Age range: 3-12 years



17.208

Metal swing Nest

width	length	height	fall height
1 460 mm	2 980 mm	2 640 mm	1 465 mm

Age range: 3-12 years



17.214

Metal Swing

width	length	height	fall height
1 481 mm	6 636 mm	2 641 mm	1 465 mm

Age range: 3-12 years



17.009

Cradle Seat

width	length	height	fall height
287 mm	480 mm	1482 mm	1200 mm

Age range: 0-3 years



17.033

Rubber Seat

width	length	height	fall height
240 mm	440 mm	1482 mm	1200 mm

Age range: 7-12 years



17.008

Seat With Back Support

width	length	height	fall height
275 mm	440 mm	215 mm	1200 mm

Age range: 3-12 years



17.031

Square Rope Seat Nest

width	length	height	fall height
1000 mm	1000 mm	1240 mm	1362 mm

Age range: 3-12 years



17.037

Rope Seat Nest

width	length	height	fall height
1000 mm	1000 mm	1100 mm	1362 mm

Age range: 3-12 years



17.039

Oval Rope Seat Nest

width	length	height	fall height
800 mm	1200 mm	1240 mm	1362 mm

Age range: 3-12 years



17.209

Steel Swing

width	length	height	fall height
1460 mm	2360 mm	2640 mm	1450 mm

Age range: 3-12 years



17.036

Parent And Child Swing Seat

width	length	height	fall height
541 mm	1256 mm	480 mm	-

Age range: 3-12 years



17.035

Secure Swing Seat

width	length	height	fall height
598 mm	610 mm	937 mm	-

Age range: 7-12 years





17.042

Swing Urban

width	length	height	fall height
1980 mm	6 030 mm	2 514 mm	1 450 mm

Age range: 3-12 years



17.045

Swing Arc

width	length	height	fall height
1300 mm	5 985 mm	2 455 mm	1 435 mm

Age range: 3-12 years





14.022

Carousel Spiral

width	length	height	fall height
1 664 mm	1 664 mm	859 mm	426 mm

Age range: 3-12 years



14.017

Carousel lowa

width	length	height	fall height
1 230 mm	1 230 mm	760 mm	489 mm

Age range: 3-12 years



14.010

Carousel Garland

width	length	height	fall height
2 000 mm	2 000 mm	1 700 mm	550 mm

Age range: 7-12 years



14.002

Carousel Cone

width	length	height	fall height
1 600 mm	1 600 mm	2 500 mm	550 mm

Age range: 7-12 years



14.005

Carousel Galaxy

width	length	height	fall height
2 200 mm	2 200 mm	1 700 mm	600 mm

Age range: 7-12 years



14.006

Carousel Nest

width	length	height	fall height
1 042 mm	1 042 mm	809 mm	809 mm

Age range: 7-12 years



RP-20704

Carousel

width	length	height	fall height
1700 mm	1700 mm	1170 mm	-

Age range: 2-12 years

**RP-20705**

Carousel

width	length	height	fall height
1700 mm	1700 mm	1000 mm	-

Age range: 2-12 years

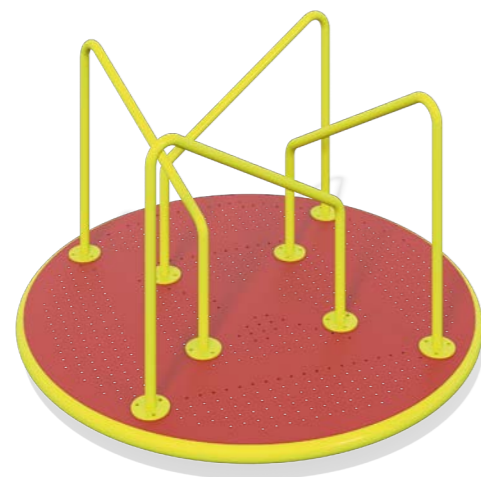
**14.023**

Carousel Missouri

width	length	height	fall height
1654 mm	1654 mm	817 mm	409 mm

Age range: 3-12 years

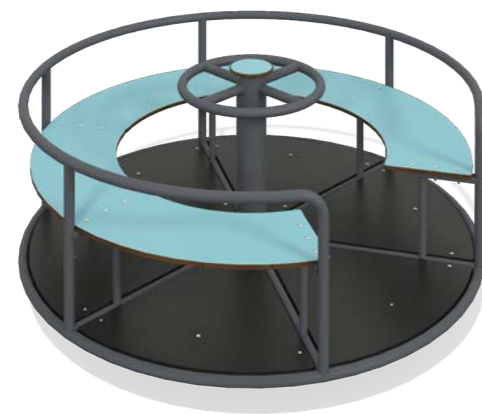
**14.024**

Carousel Arizona

width	length	height	fall height
1654 mm	1654 mm	797 mm	452 mm

Age range: 3-12 years

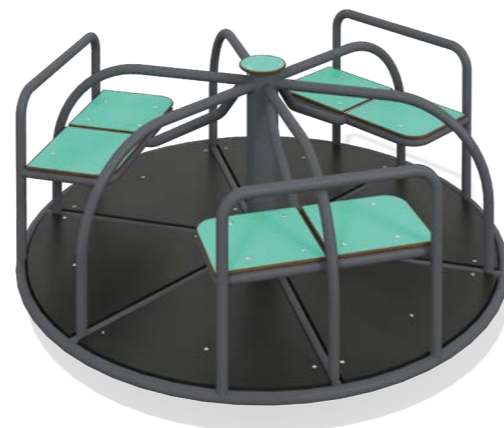
**14.025**

Carousel Utah

width	length	height	fall height
450 mm	450 mm	377 mm	302 mm

Age range: 3-7 years

**14.011**

Carousel Hamilton

width	length	height	fall height
1240 mm	1240 mm	1000 mm	397 mm

Age range: 7-12 years

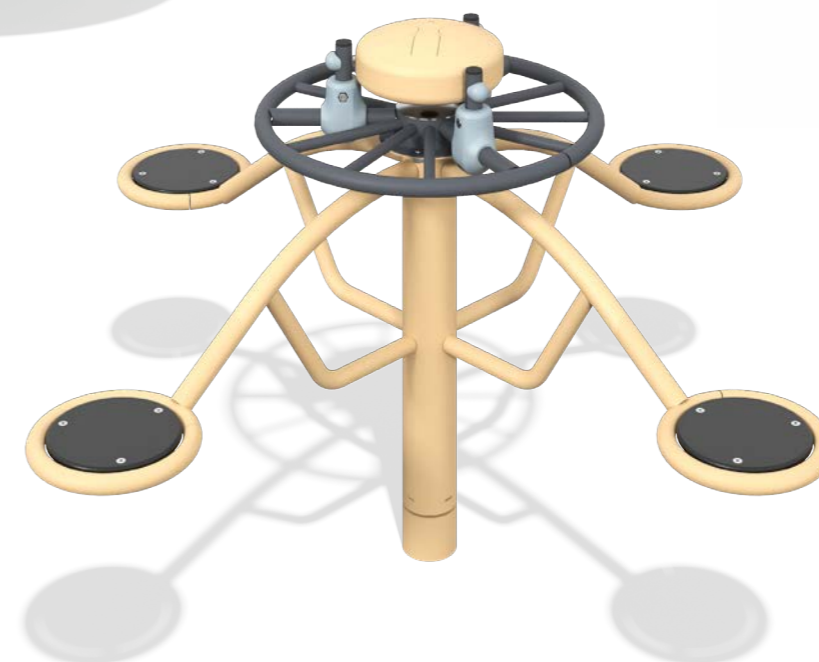
**14.007**

Carousel Quebec

width	length	height	fall height
1847 mm	1847 mm	842 mm	536 mm

Age range: 7-12 years

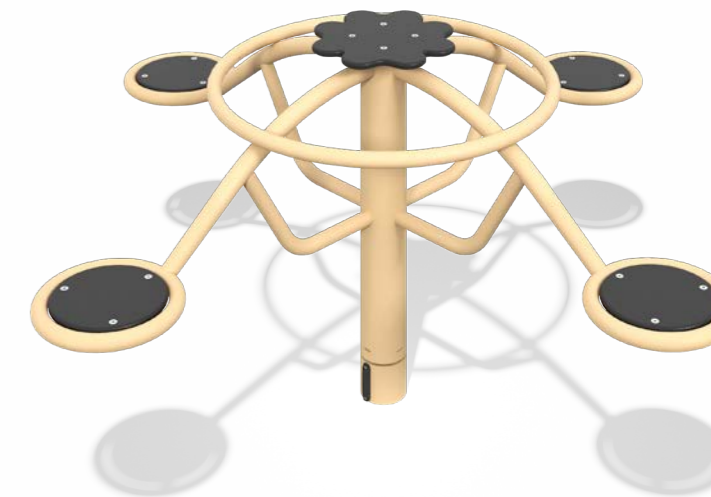
**14.021**

Carousel Frequency

width	length	height	fall height
1847 mm	1847 mm	1046 mm	537 mm

Age range: 7-12 years





11.021

Seesaw with spring

width	length	height	fall height
581 mm	1628 mm	928 mm	592 mm

Age range: 3-7 years

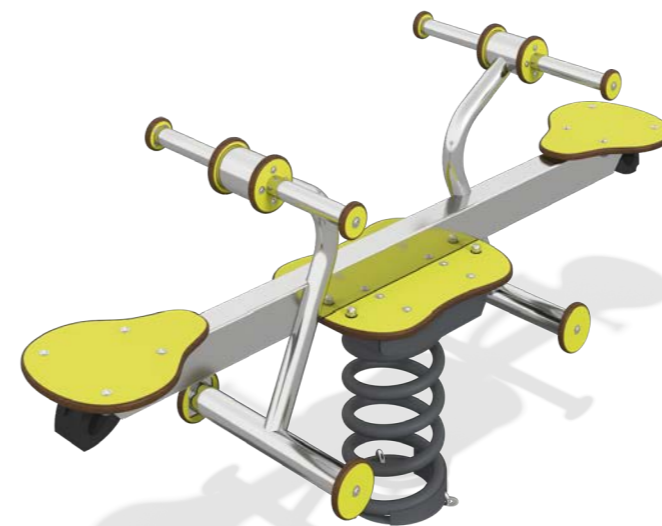

11.012

Seesaw Sydney

width	length	height	fall height
720 mm	1705 mm	753 mm	700 mm

Age range: 3-6 years

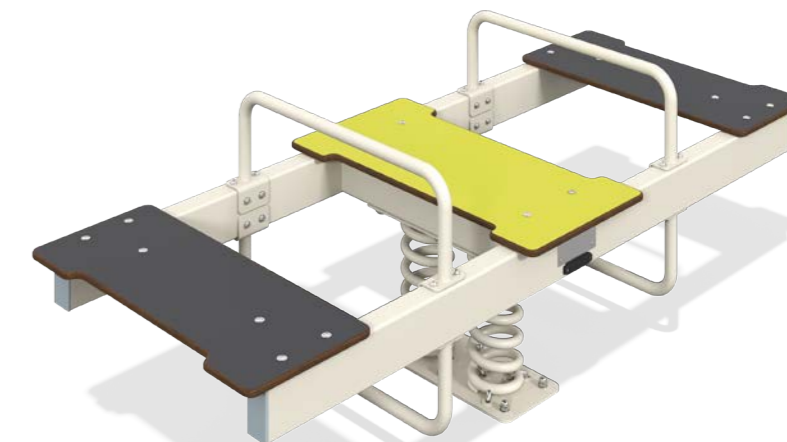

ES-20108

Seesaw

width	length	height	fall height
1780 mm	2 040 mm	840 mm	450 mm

Age range: 2-12 years



11.014

Seesaw Fretboard

width	length	height	fall height
526 mm	2 650 mm	671 mm	678 mm

Age range: 3-12 years

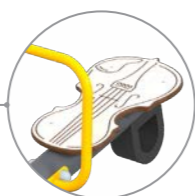
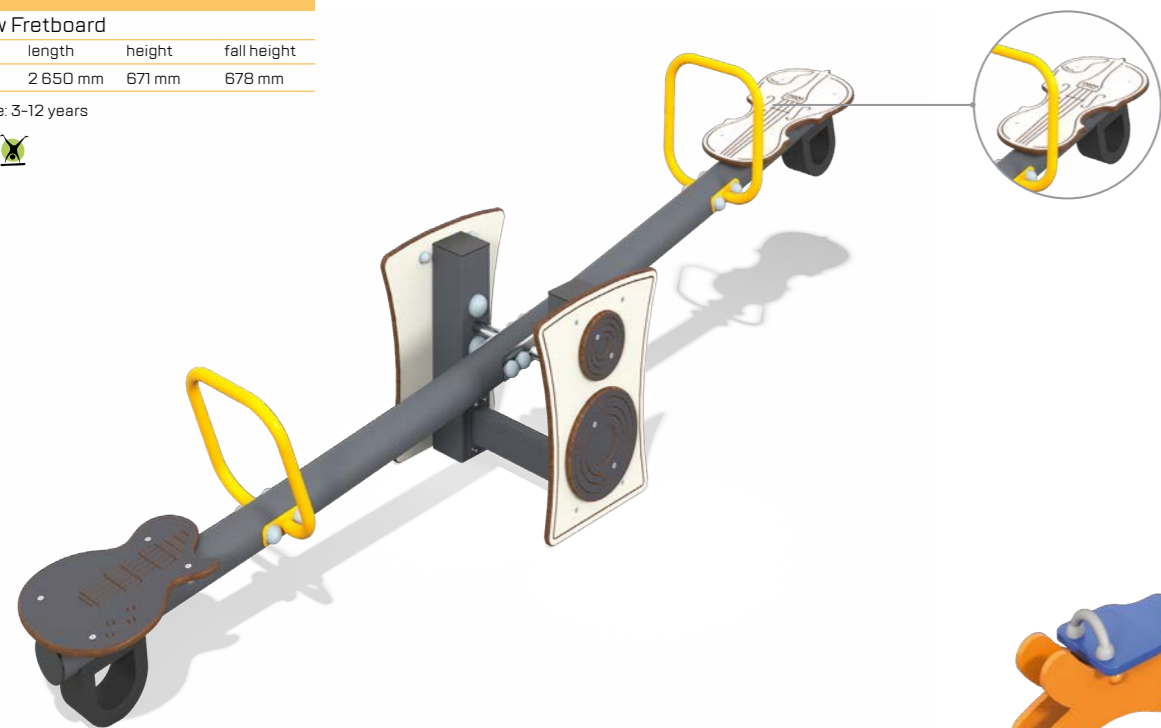

ES-20106

Seesaw

width	length	height	fall height
580 mm	3 160 mm	830 mm	

Age range: 2-12 years



ES-20101

Seesaw

width	length	height	fall height
610 mm	3 130 mm	880 mm	

Age range: 2-12 years

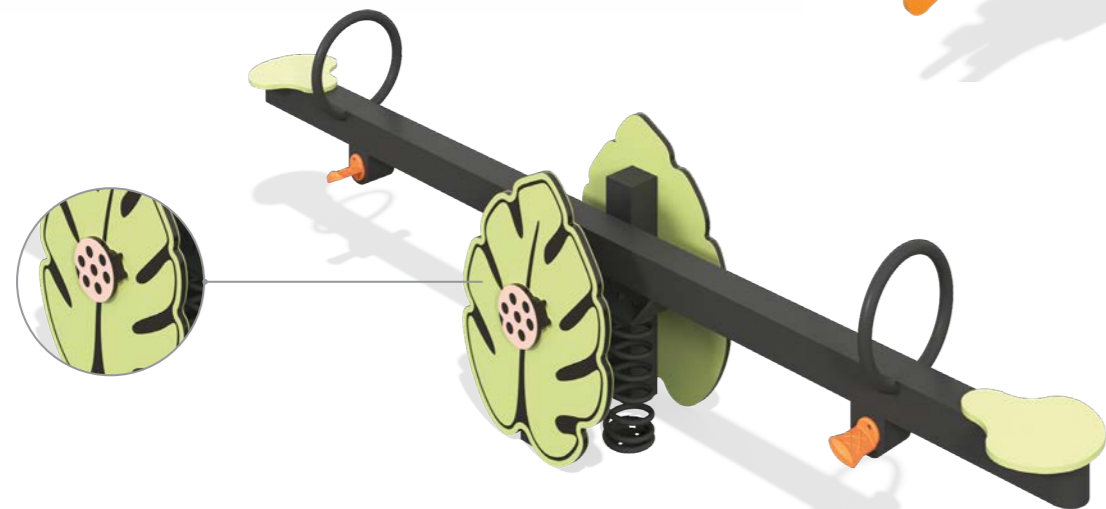

11.013

Seesaw Singapore

width	length	height	fall height
482 mm	2 602 mm	638 mm	519 mm

Age range: 3-12 years

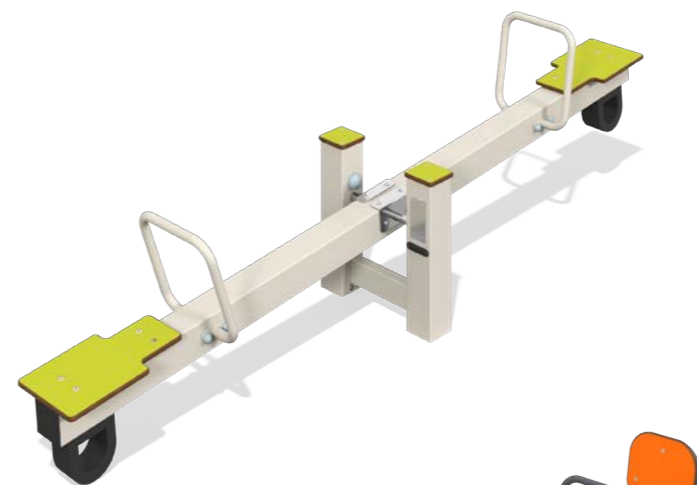

11.019

Seesaw Portal

width	length	height	fall height
482 mm	2 652 mm	676 mm	527 mm

Age range: 3-12 years

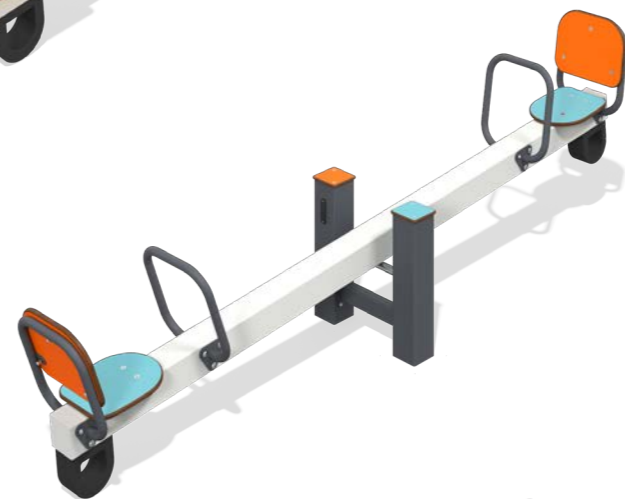

11.015

Seesaw Level

width	length	height	fall height
480 mm	2 600 mm	660 mm	536 mm

Age range: 3-12 years

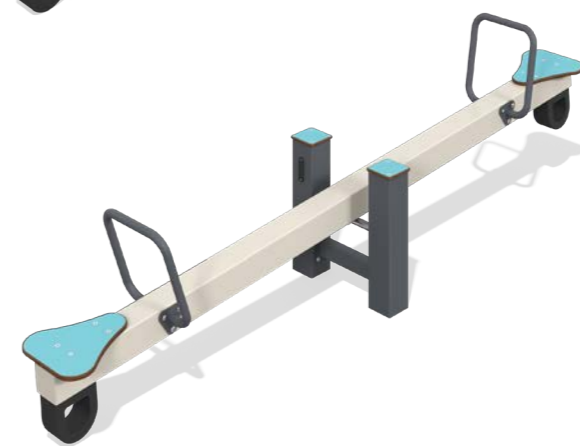

11.017

Seesaw Apples and pears

width	length	height	fall height
482 mm	2 648 mm	676 mm	680 mm

Age range: 3-12 years



11.020

Seesaw Discovery

width	length	height	fall height
498 mm	2 652 mm	676 mm	525 mm

Age range: 3-12 years

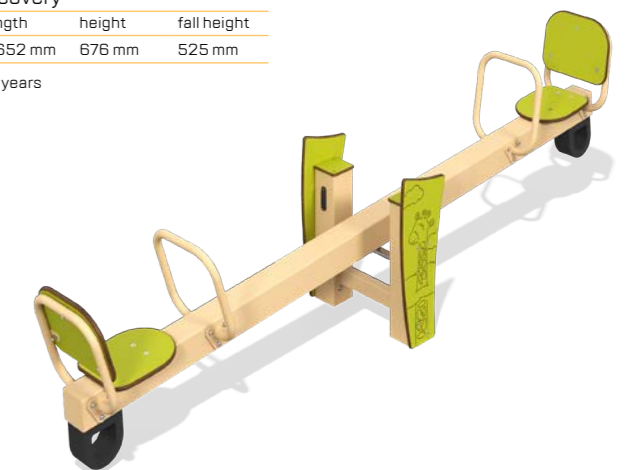

16.044**Spring Rider Bronotosaurus**

width	length	height	fall height
380 mm	665 mm	905 mm	502 mm

Age range: 3-7 years

**16.050****Spring Rider Triceratops**

width	length	height	fall height
380 mm	755 mm	951 mm	517 mm

Age range: 3-7 years

**16.042****Spring Rider Ceratops**

width	length	height	fall height
380 mm	655 mm	785 mm	433 mm

Age range: 3-7 years

**16.056****Spring Rider Tynnosaurus**

width	length	height	fall height
380 mm	704 mm	850 mm	433 mm

Age range: 3-7 years

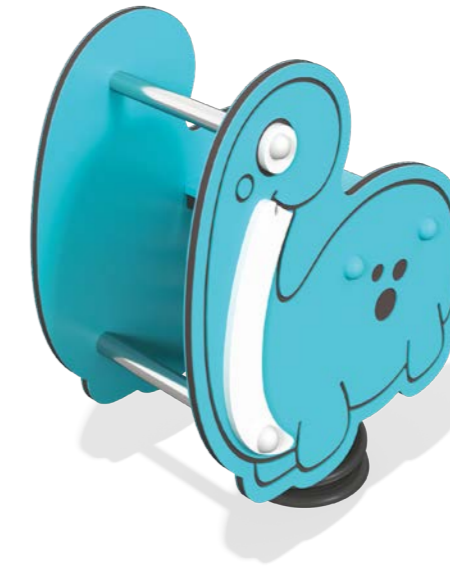
**PE.SR-19804****Spring rider**

width	length	height	fall height
420 mm	600 mm	810 mm	

Age range: 2-12 years

**16.045****Spring Rider Stegosaurus**

width	length	height	fall height
380 mm	719 mm	777 mm	433 mm

Age range: 3-7 years





16.051

Spring Rider Portal

width	length	height	fall height
380 mm	600 mm	900 mm	433 mm

Age range: 3-7 years



16.052

Spring Rider Stump

width	length	height	fall height
587 mm	765 mm	854 mm	410 mm

Age range: 3-7 years



16.053

Spring Rider Antelope

width	length	height	fall height
748 mm	763 mm	1200 mm	502 mm

Age range: 3-7 years

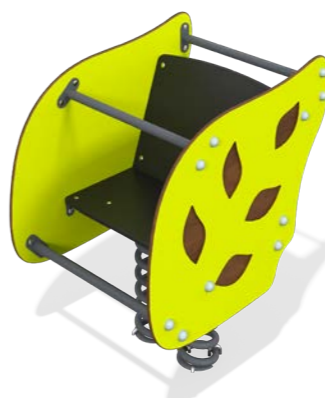

16.055

Spring Rider Star

width	length	height	fall height
380 mm	600 mm	805 mm	500 mm

Age range: 3-7 years



16.046

Spring Rider Dachshund

width	length	height	fall height
380 mm	706 mm	787 mm	433 mm

Age range: 3-7 years



16.047

Spring Rider Cat with a ball

width	length	height	fall height
380 mm	717 mm	820 mm	433 mm

Age range: 3-7 years

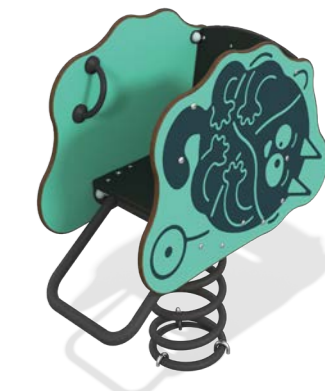

16.048

Spring Rider Fish

width	length	height	fall height
406 mm	795 mm	1191 mm	488 mm

Age range: 3-7 years

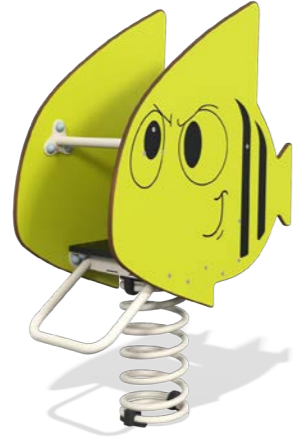

16.038

Spring Rider Chicago

width	length	height	fall height
406 mm	732 mm	994 mm	488 mm

Age range: 3-7 years

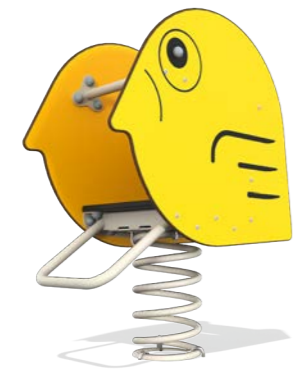

16.034

Spring Rider Nest

width	length	height	fall height
1000 mm	1000 mm	645 mm	645 mm

Age range: 3-12 years

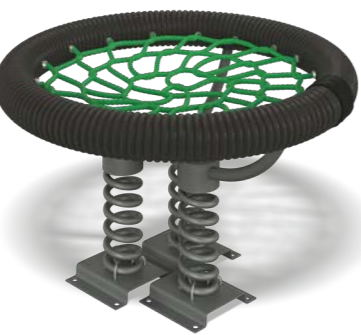

16.057

Spring Rider Kansas

width	length	height	fall height
450 mm	500 mm	504 mm	429 mm

Age range: 3-7 years



PE.SR-19906

Spring rider

width	length	height	fall height
420 mm	620 mm	810 mm	

Age range: 2-12 years



PE.SR-19802

Spring rider

width	length	height	fall height
420 mm	740 mm	970 mm	

Age range: 2-12 years



PE.SR-19709

Spring rider

width	length	height	fall height
390 mm	720 mm	810 mm	

Age range: 2-12 years

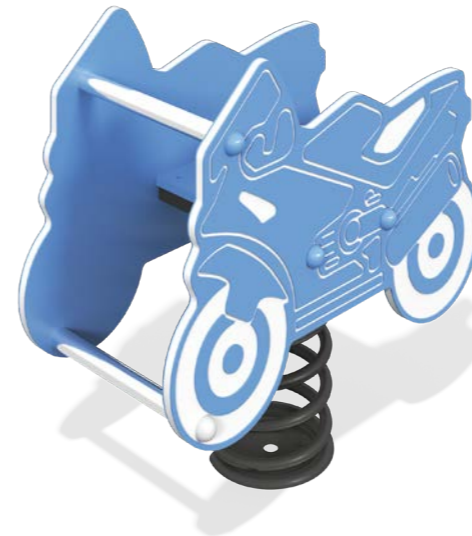

16.054

Spring Rider Boombox

width	length	height	fall height
548 mm	804 mm	886 mm	522 mm

Age range: 3-7 years

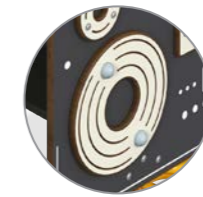

PE.SR-19707

Spring rider

width	length	height	fall height
410 mm	710 mm	800 mm	

Age range: 2-12 years





19.066
Sandpit Safari

width	length	height	fall height
4 000 mm	4 085 mm	1 960 mm	570 mm

Age range: 3-12 years

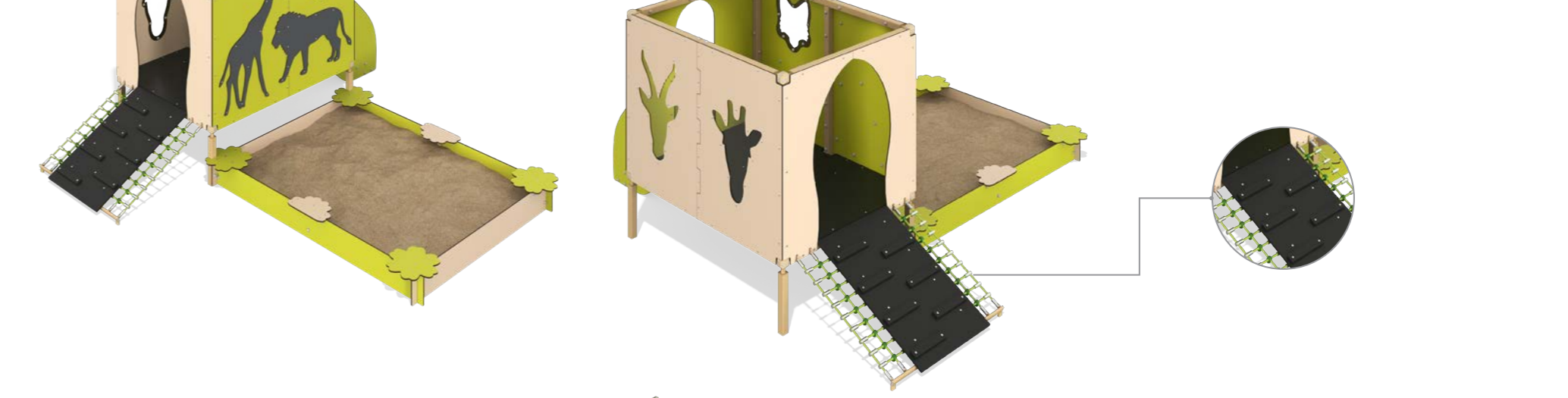

19.068
Sandpit Safari mini

width	length	height	fall height
2 575 mm	3 565 mm	1 793 mm	655 mm

Age range: 3-12 years

19.047

Sandpit Indians

width	length	height	fall height
2 615 mm	2 615 mm	255 mm	255 mm

Age range: 3-6 years

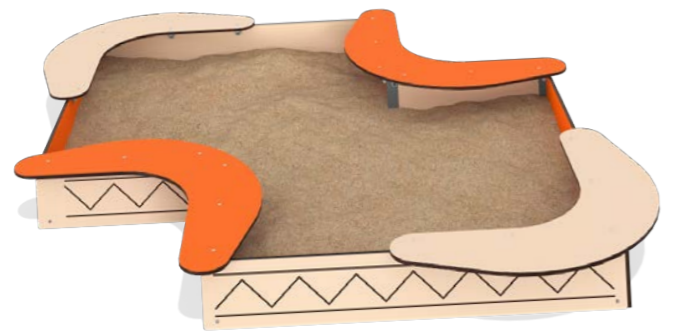

19.041

Sandpit Constructivism

width	length	height	fall height
1 200 mm	2 013 mm	250 mm	250 mm

Age range: 3-6 years



19.049

Sandpit Transport

width	length	height	fall height
1 515 mm	1 740 mm	250 mm	250 mm

Age range: 3-6 years



19.026

Sandpit Mountains and forests

width	length	height	fall height
1 000 mm	1 000 mm	750 mm	750 mm

Age range: 3-6 years



19.027

Sandpit Beach

width	length	height	fall height
1 000 mm	1 000 mm	715 mm	715 mm

Age range: 3-6 years

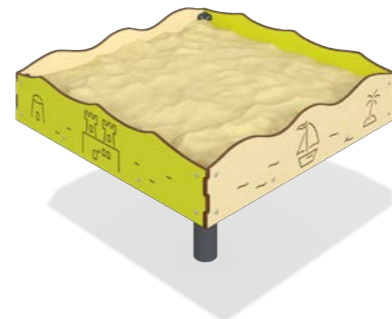

19.019

Sandpit Galaxy

width	length	height	fall height
1 000 mm	1 000 mm	700 mm	700 mm

Age range: 3-6 years

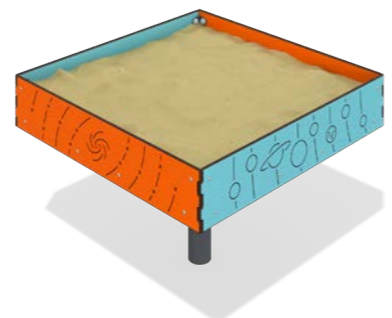

19.067

Sandpit Gravity

width	length	height	fall height
2 125 mm	2 125 mm	1 018 mm	1 018 mm

Age range: 3-6 years

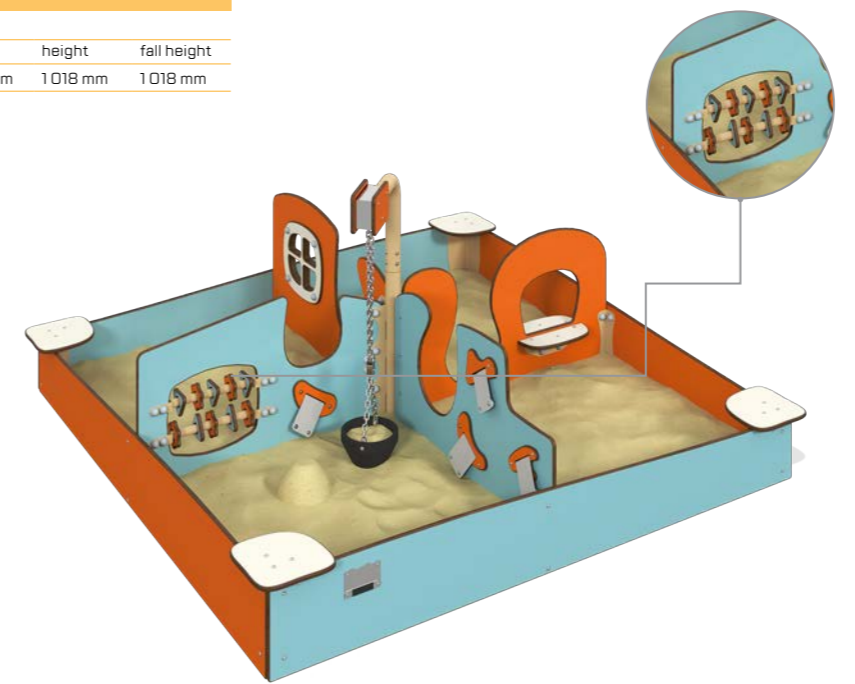

19.037

Sand Play Equipment Sea with a lid

width	length	height	fall height
1 300 mm	1 300 mm	460 mm	300 mm

Age range: 3-7 years

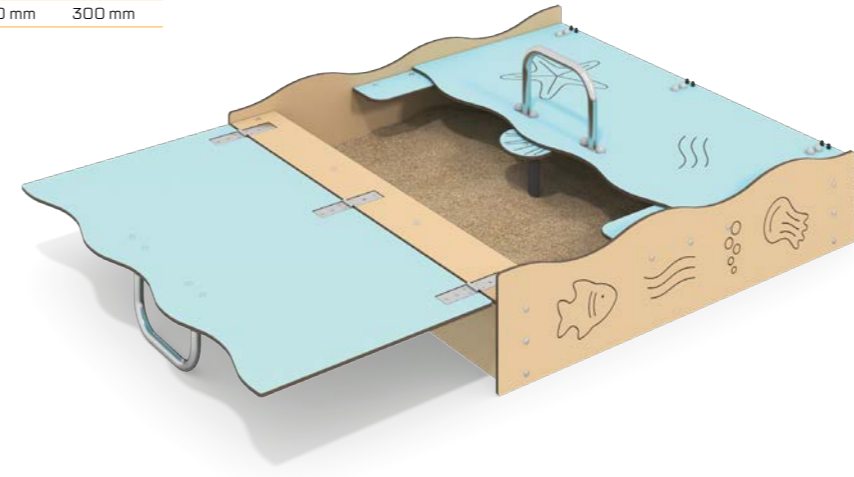

19.022

Sandpit Galaxy

width	length	height	fall height
1 675 mm	1 675 mm	255 mm	255 mm

Age range: 3-7 years

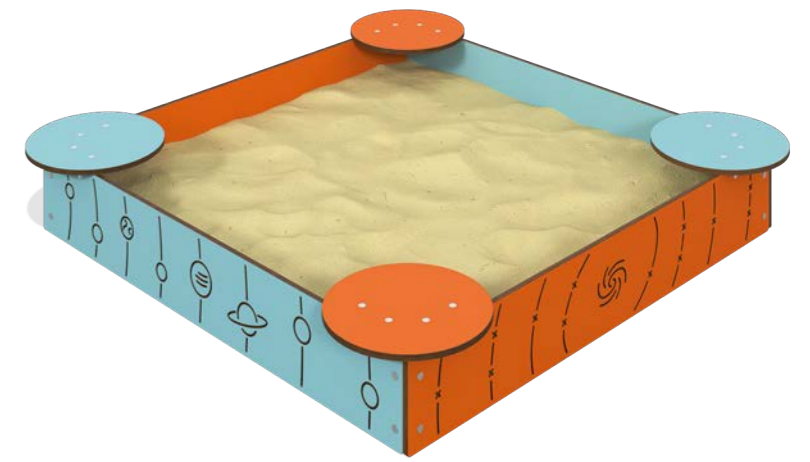

18.023

Outdoor table Sieve

width	length	height	fall height
420 mm	750 mm	200 mm	200 mm

Age range: 2-7 years



19.070

Sandpit Wisconsin

width	length	height	fall height
3 000 mm	3 000 mm	1 875 mm	720 mm

Age range: 3-7 years



19.065

Sandpit Numeric

width	length	height	fall height
2 650 mm	2 810 mm	2 280 mm	553 mm

Age range: 3-7 years



19.072

Sandpit Virginia

width	length	height	fall height
2 215 mm	3 385 mm	2 350 mm	735 mm

Age range: 3-7 years



19.069

Sand yard Bahamas

width	length	height	fall height
1 450 mm	2 215 mm	1 935 mm	260 mm

Age range: 3-7 years



18.019

Outdoor table Village

width	length	height	fall height
1 150 mm	1 150 mm	500 mm	300 mm

Age range: 2-7 years



19.071

Sandpit California

width	length	height	fall height
1 550 mm	2 565 mm	1 310 mm	-

Age range: 3-7 years





23.026

Educational Module Glockenspiel

width	length	height	fall height
500 mm	1200 mm	750 mm	

Age range: 3-12 years

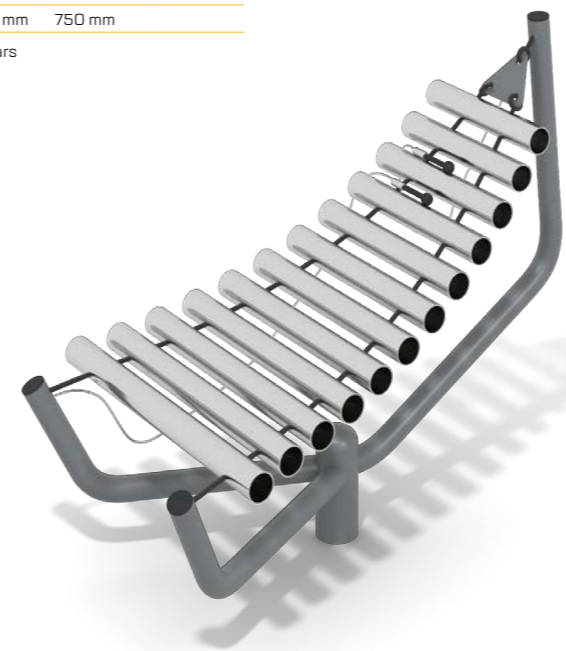

23.021

Educational Module Glockenspiel

width	length	height	fall height
724 mm	844 mm	588 mm	

Age range: 3-12 years



23.047

Educational Module Digger

width	length	height	fall height
240 mm	1100 mm	700 mm	310 mm

Age range: 3-12 years





23.009

Educational Module Orchestra

width	length	height	fall height
2 300 mm	3 400 mm	1 400 mm	-

Age range: 3-12 years



23.022

Educational Module Glucophone

width	length	height	fall height
380 mm	380 mm	670 mm	-

Age range: 3-12 years



23.005

Educational Module Drummer installation

width	length	height	fall height
625 mm	1 600 mm	600 mm	-

Age range: 3-12 years



23.015

Double stand Cat and Dog

width	length	height	fall height
108 mm	1360 mm	1167 mm	-

Age range: 3-7 years



23.019

Game Panel Races

width	length	height	fall height
111 mm	770 mm	1160 mm	-

Age range: 3-7 years



23.035

Educational Module Gear Wheels

width	length	height	fall height
235 mm	920 mm	1132 mm	-

Age range: 3-7 years

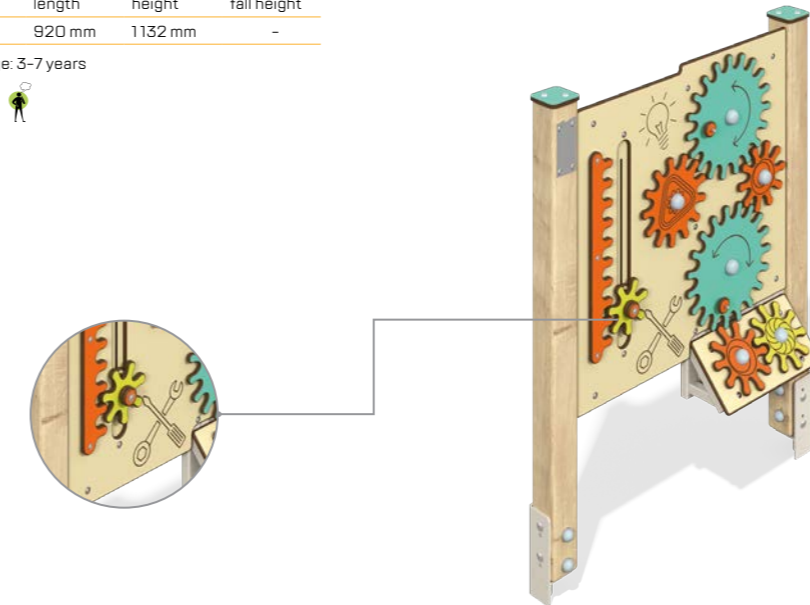

23.034

Educational Module Sprockets

width	length	height	fall height
110 mm	740 mm	1165 mm	-

Age range: 3-7 years



23.033

Educational Module Illusion

width	length	height	fall height
164 mm	770 mm	1272 mm	-

Age range: 3-12 years

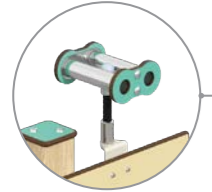

23.032

Game panel Solar System

width	length	height	fall height
123 mm	770 mm	1160 mm	-

Age range: 3-7 years



23.017

Play Panel DJ Console

width	length	height	fall height
402 mm	870 mm	1167 mm	-

Age range: 3-7 years



23.036

Educational Module Xylophone

width	length	height	fall height
150 mm	770 mm	1160 mm	-

Age range: 3-12 years



23.031

Educational Module Xylophone Illusion

width	length	height	fall height
820 mm	830 mm	1300 mm	-

Age range: 3-12 years

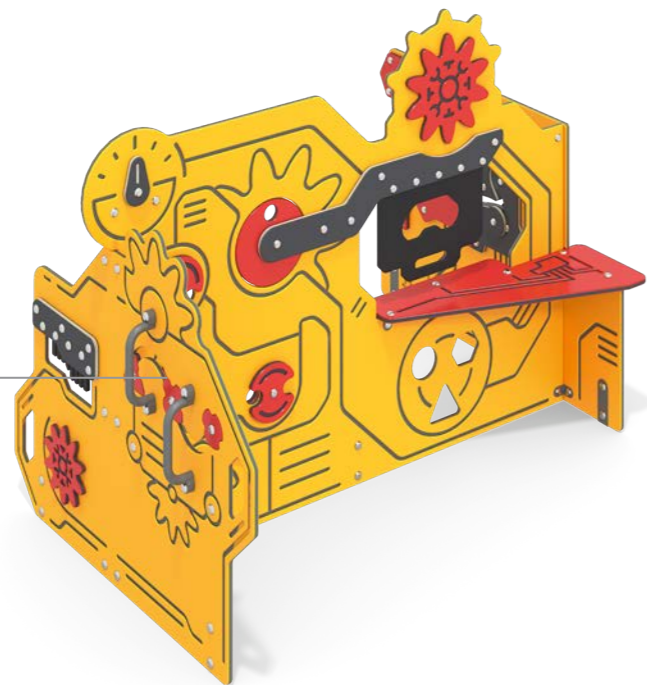
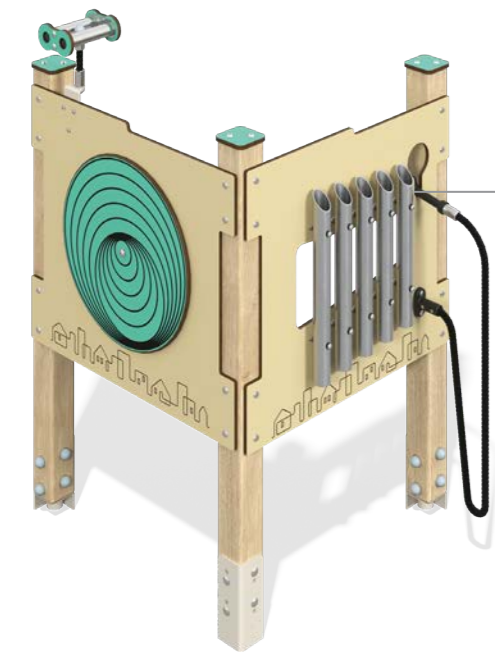

23.001

Play Panel Gas station

width	length	height	fall height
660 mm	1269 mm	1757 mm	-

Age range: 3-7 years

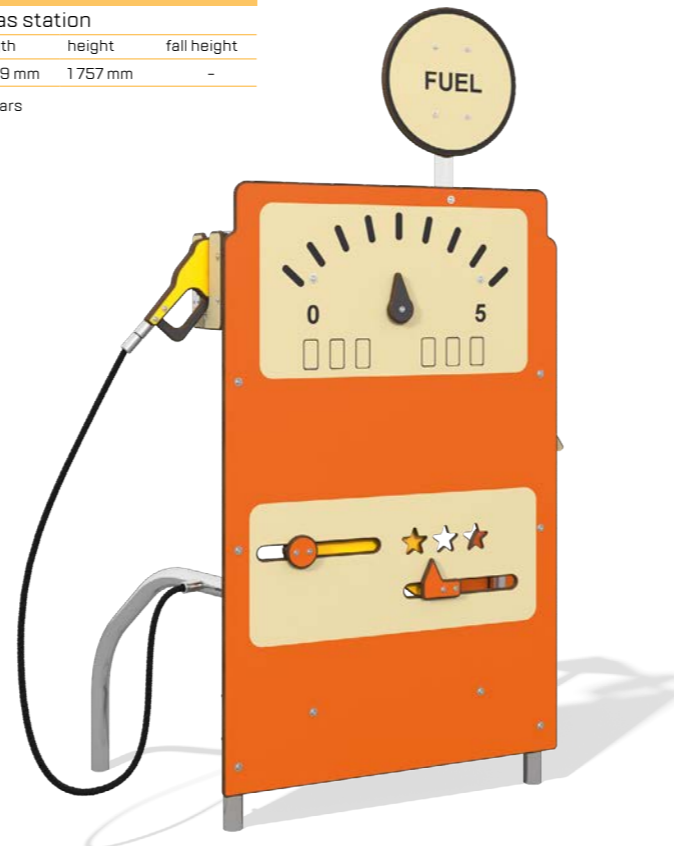

23.007

Educational Module Mechanic

width	length	height	fall height
1450 mm	1650 mm	1200 mm	-

Age range: 3-7 years



23.037

Play Panel Food Chain

width	length	height	fall height
85 mm	1179 mm	1261 mm	-

Age range: 3-12 years



23.013

Game panel Tic Tac Toe

width	length	height	fall height
48 mm	1179 mm	1261 mm	-

Age range: 3-12 years



44.002

Educational Module Gates

width	length	height	fall height
340 mm	466 mm	700 mm	-

Age range: 3-12 years



44.001

Educational Module Billiards

width	length	height	fall height
340 mm	466 mm	700 mm	-

Age range: 3-12 years





SPORTS AND PLAY SYSTEMS

MG4207

Sports and Play System

width	length	height	fall height
5 344 mm	6 565 mm	2 805 mm	2 565 mm

Age range: 6-12 years

**MG4210**

Sports and Play System

width	length	height	fall height
3 182 mm	3 277 mm	2 801 mm	2 400 mm

Age range: 6-14 years

**MG0512.1**

Rope Swing

width	length	height	fall height
3 200 mm	5 602 mm	3 874 mm	1 850 mm

Age range: 6-12 years

**MG3538**

Sports equipment

width	length	height	fall height
1 250 mm	3 800 mm	1 400 mm	400 mm

Age range: 3-12 years

**MG4208**

Sports and Play System

width	length	height	fall height
1 961 mm	1 988 mm	2 584 mm	2 373 mm

Age range: 5-12 years



24.005**Sports and Play System Tundra**

width	length	height	fall height
5 900 mm	5 900 mm	2 800 mm	2 500 mm

Age range: 7-12 years

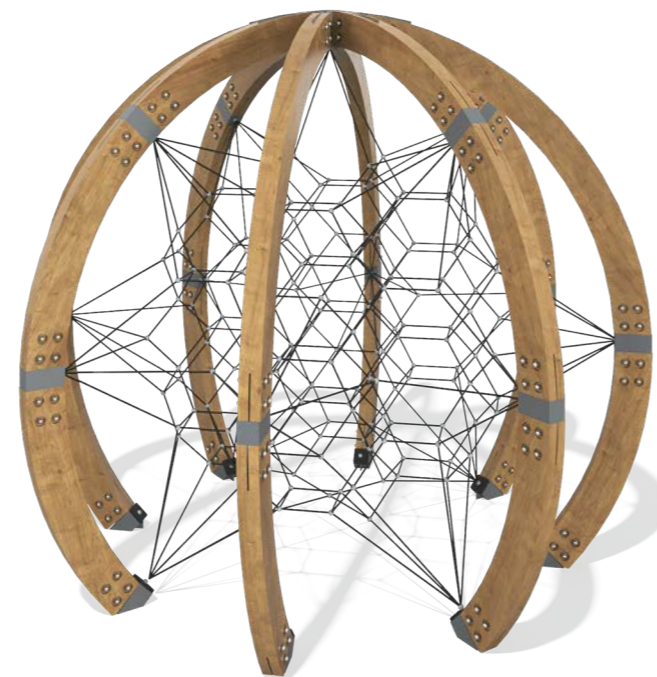
**24.004****Sports and Play System Nobile**

width	length	height	fall height
5 000 mm	5 000 mm	4 500 mm	2 100 mm

Age range: 7-12 years

**24.007****Sports and Play System Kamchatka**

width	length	height	fall height
3 800 mm	3 800 mm	1 500 mm	550 mm

Age range: 3-12 years

**24.003****Sports and Play System Crossing**

width	length	height	fall height
550 mm	2 500 mm	1 500 mm	440 mm

Age range: 3-12 years

**MG3529****Sports equipment Log**

width	length	height	fall height
440 mm	3 040 mm	535 mm	535 mm

Age range: 3-12 years

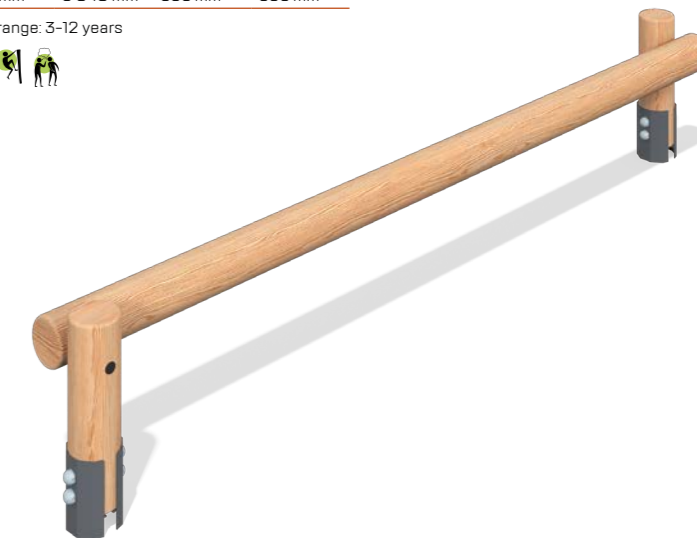
**MG3533****Sports equipment**

width	length	height	fall height
550 mm	2 950 mm	1 500 mm	-

Age range: 3-12 years

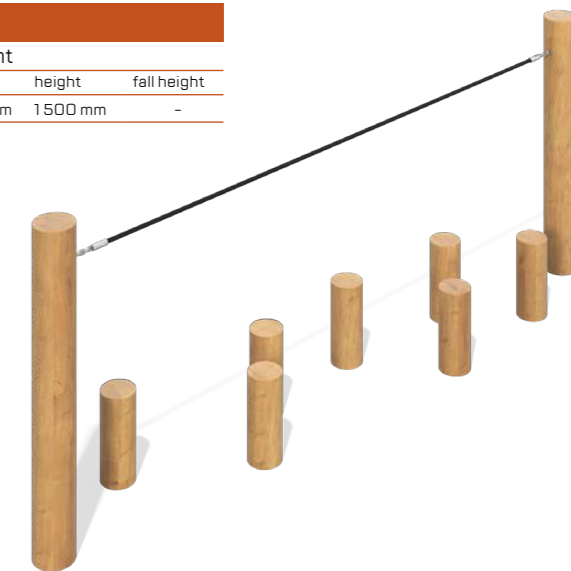

28.021**Youth Fitness Equipment Scout**

width	length	height	fall height
4 646 mm	7 232 mm	1 967 mm	1 850 mm

Age range: 3-7 years

**28.019****Youth Fitness Equipment Climber**

width	length	height	fall height
3 626 mm	5 010 mm	1 960 mm	1 850 mm

Age range: 3-7 years

**28.036****Youth Fitness Equipment Anaconda**

width	length	height	fall height
3 710 mm	6 613 mm	1 690 mm	350 mm

Age range: 3-7 years

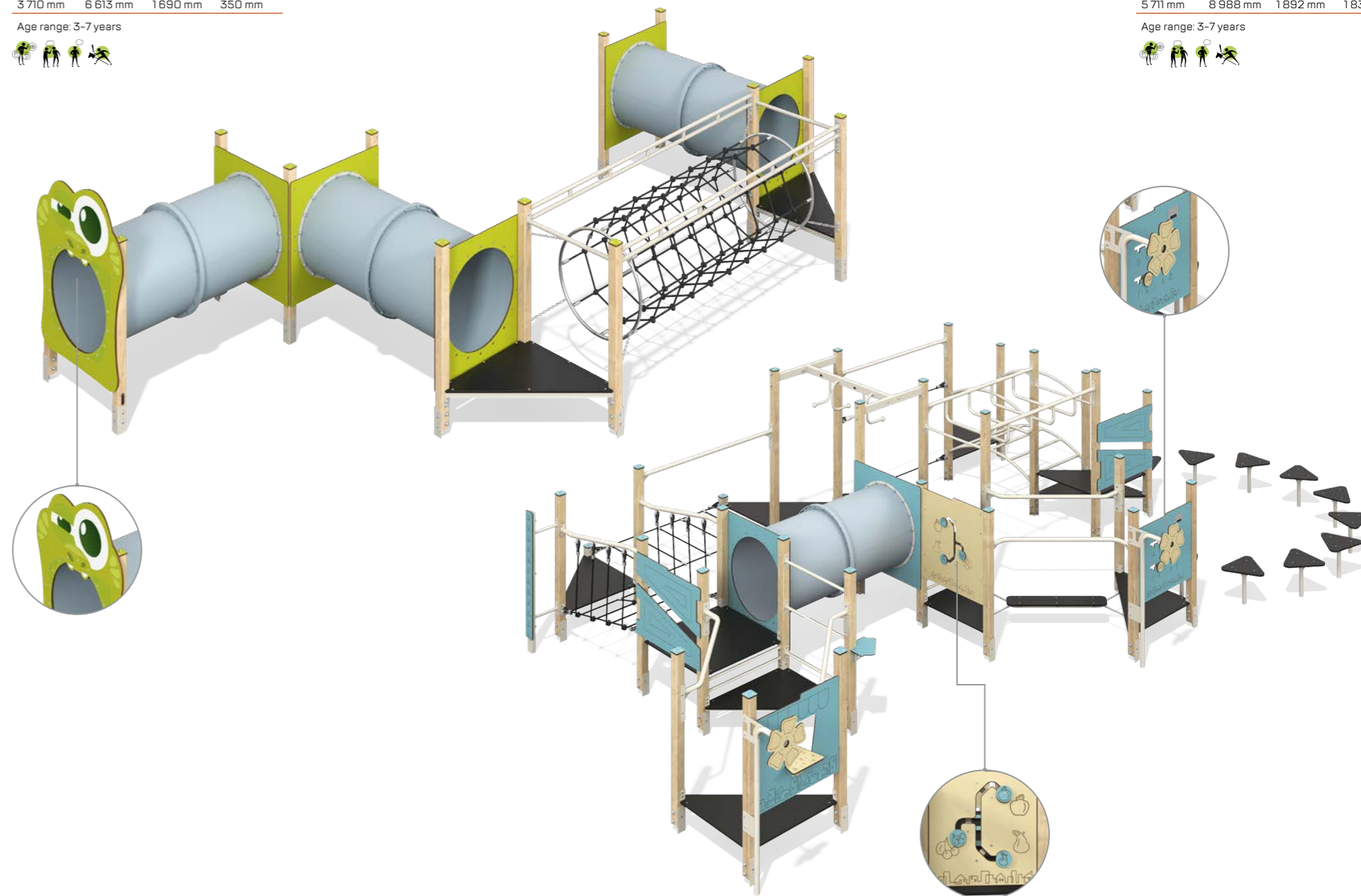
**28.025****Youth Fitness Equipment Ranger**

width	length	height	fall height
5 711 mm	8 988 mm	1 892 mm	1 832 mm

Age range: 3-7 years



28.035

Youth Fitness Equipment Goal

width	length	height	fall height
2 590 mm	2 590 mm	1 660 mm	1 543 mm

Age range: 3-7 years

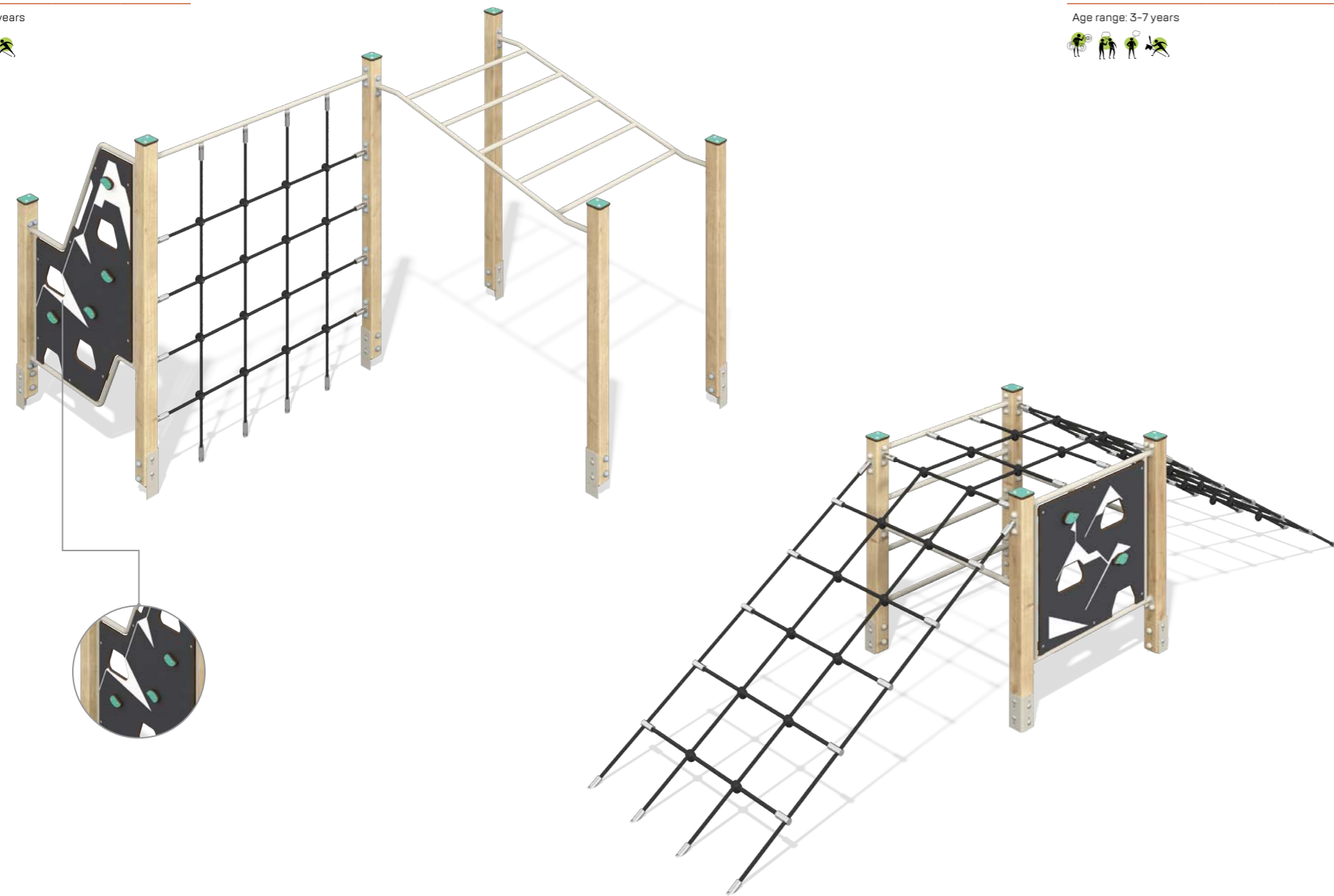
**28.032**

Youth Fitness Equipment Hero

width	length	height	fall height
1 010 mm	4 030 mm	1 060 mm	1 060 mm

Age range: 3-7 years

**28.029**

Youth Fitness Equipment Athlete

width	length	height	fall height
1 090 mm	1 590 mm	1 660 mm	1 573 mm

Age range: 3-7 years

**28.026**

Youth Fitness Equipment Energy

width	length	height	fall height
1 090 mm	2 590 mm	1 090 mm	973 mm

Age range: 3-7 years

**28.033**

Youth Fitness Equipment Gymnastic

width	length	height	fall height
1 690 mm	1 590 mm	1 660 mm	1 573 mm

Age range: 3-7 years



28.027**Youth Fitness Equipment Olympics**

width	length	height	fall height
3 090 mm	3 590 mm	1 660 mm	1 573 mm

Age range: 3-7 years

**28.028****Youth Fitness Equipment Master**

width	length	height	fall height
1 090 mm	1 590 mm	1 660 mm	1 573 mm

Age range: 3-7 years

**28.031****Youth Fitness Equipment Movement**

width	length	height	fall height
1 370 mm	3 870 mm	1 960 mm	1 873 mm

Age range: 3-7 years

**28.034****Youth Fitness Equipment Sprint**

width	length	height	fall height
2 810 mm	5 590 mm	1 660 mm	1 573 mm

Age range: 3-7 years



RP-18002

Freestanding Climbing Series
Outdoor Playground

width	length	height	fall height
9 000 mm	10 000 mm	2 700 mm	

Age range: 2-12 years



RPS-18502

Fitness equipment exercise

width	length	height	fall height
3 900 mm	11 100 mm	3 500 mm	

Age range: 2-12 years



RPS-18201

Games of Trails Series

width	length	height	fall height
3 300 mm	12 600 mm	3 500 mm	

Age range: 2-12 years





TRAMPOLINES

Trampoline square

25.001

width	length	height	fall height
1350 mm	1350 mm	0 mm	650 mm

25.002

width	length	height	fall height
1600 mm	1600 mm	0 mm	650 mm

25.013

width	length	height	fall height
1800 mm	1800 mm	0 mm	650 mm

25.003

width	length	height	fall height
2100 mm	2100 mm	0 mm	650 mm

Age range: 3-12 years

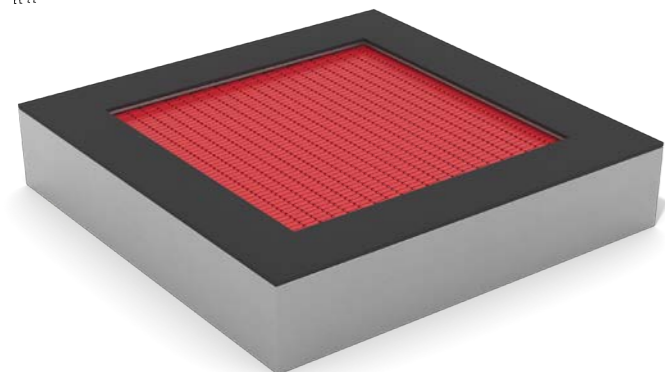

25.011

Trampoline Rectangular

width	length	height	fall height
1350 mm	2250 mm	0 mm	650 mm

Age range: 3-12 years



Trampoline round

25.009

width	length	height	fall height
1600 mm	1600 mm	0 mm	650 mm

25.012

width	length	height	fall height
1900 mm	1900 mm	0 mm	650 mm

25.010

width	length	height	fall height
2100 mm	2100 mm	0 mm	650 mm

Age range: 3-12 years



25.005

Trampoline Four squares

width	length	height	fall height
2700 mm	2700 mm	0 mm	650 mm

Age range: 3-12 years

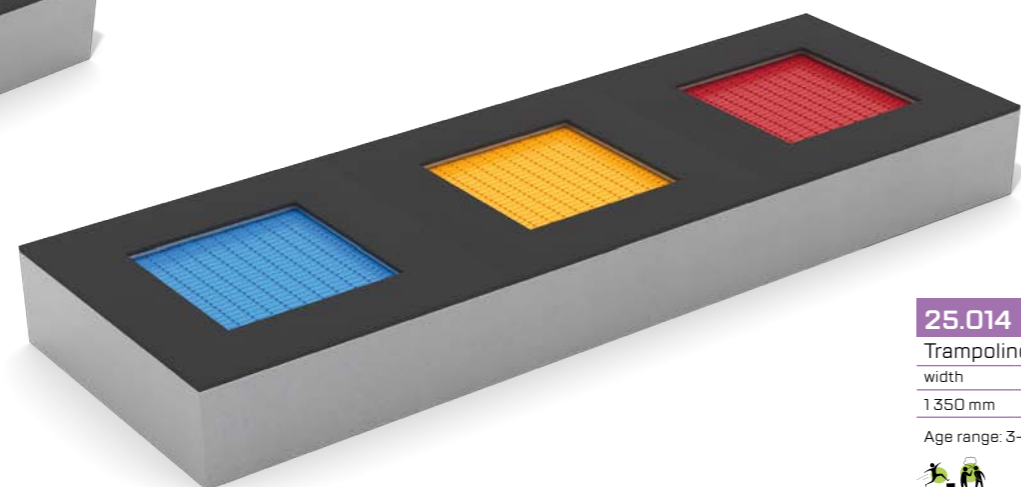
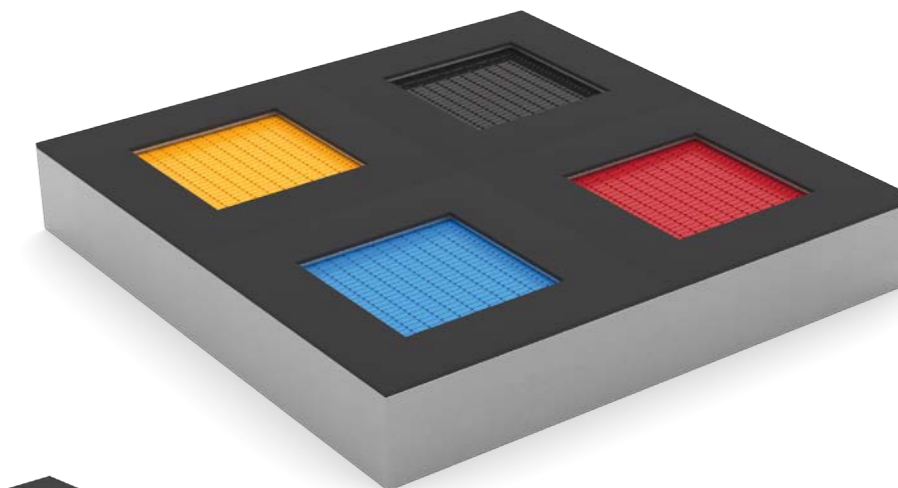

25.014

Trampoline 3-squared

width	length	height	fall height
1350 mm	4050 mm	0 mm	650 mm

Age range: 3-12 years



25.015

Trampoline 2-squared and rectangular

width	length	height	fall height
1350 mm	4950 mm	0 mm	650 mm

Age range: 3-12 years

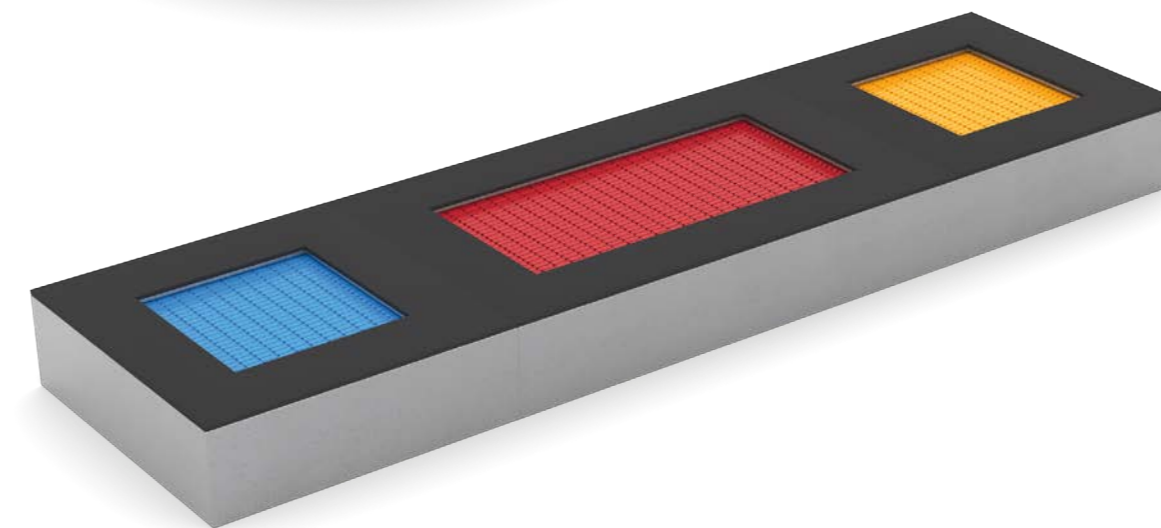

Our in-ground trampolines seamlessly blend into any landscape, adding an exciting element of motion and energy without disrupting the visual harmony of the space. Choose from a variety of shapes and sizes — with the option to add built-in LED lighting that makes the jumping experience even more magical after dark.

Safe, easy to install, and loved by children of all ages, these trampolines create a playful atmosphere and bring movement to playgrounds and parks.



Trampoline square with light (rubber)

25.024			
width	length	height	fall height
1 540 mm	1 540 mm	380 mm	-

25.025			
width	length	height	fall height
1 780 mm	1 780 mm	380 mm	-

Age range: 3-12 years

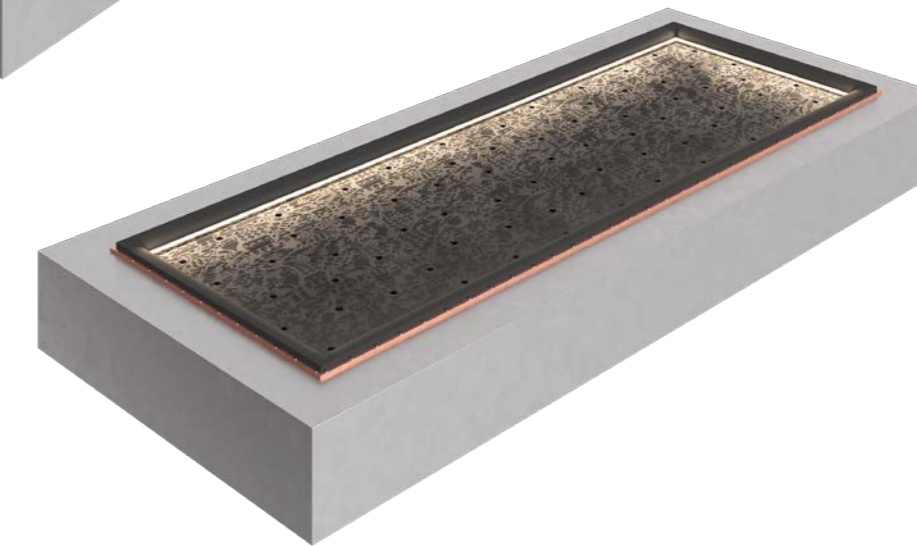
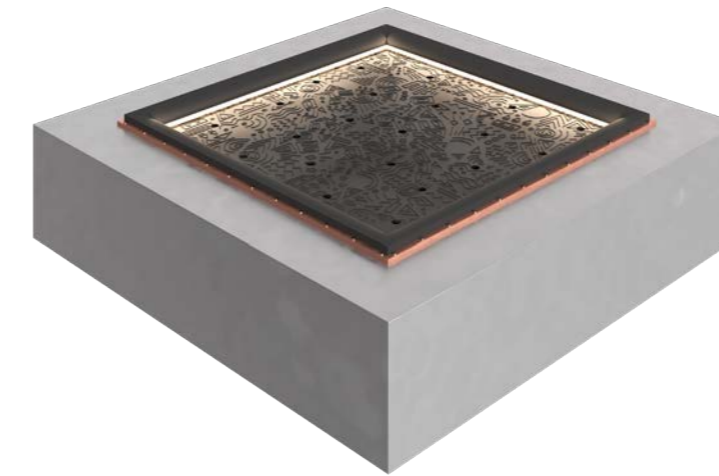

Trampoline round with light (rubber)

25.022			
width	length	height	fall height
1 600 mm	1 600 mm	380 mm	-

25.023			
width	length	height	fall height
1 840 mm	1 840 mm	380 mm	-

Age range: 3-12 years



25.026

Trampoline rectangular with light (rubber)

width	length	height	fall height
3 560 mm	1 540 mm	380 mm	-

Age range: 3-12 years





GEOPLASTICS



43.032

Geoplastic slide with platform

width	length	height	fall height
1 060 mm	3 700 mm	2 600 mm	1 780 mm

Age range: 6-12 years



ML3515.2

Pipe hooks

width	length	height	fall height
2 282 mm	2 298 mm	2 600 mm	-

Age range: 6-12 years

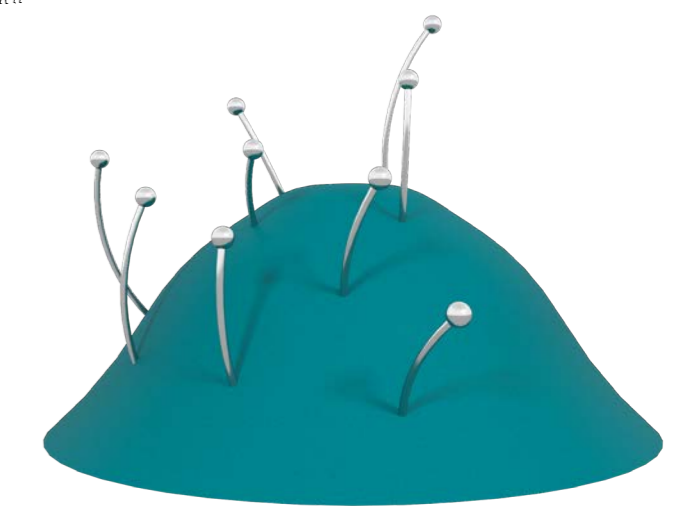

ML3515.1

Pipe hooks

width	length	height	fall height
1 725 mm	2 000 mm	900 mm	-

Age range: 6-12 years

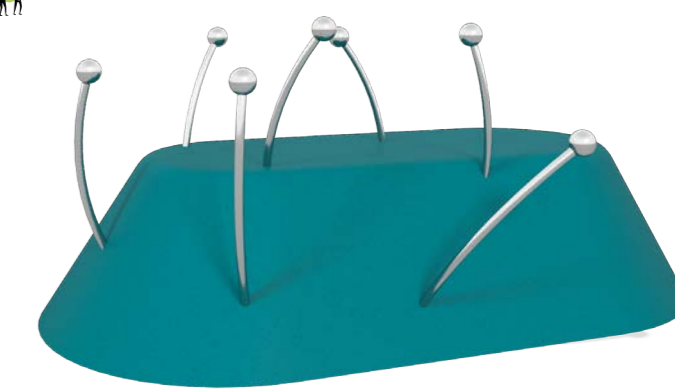



25.004

Trampoline Geoplasty d = 1350

width	length	height	fall height
2 000 mm	2 000 mm	320 mm	900 mm

Age range: 3-12 years

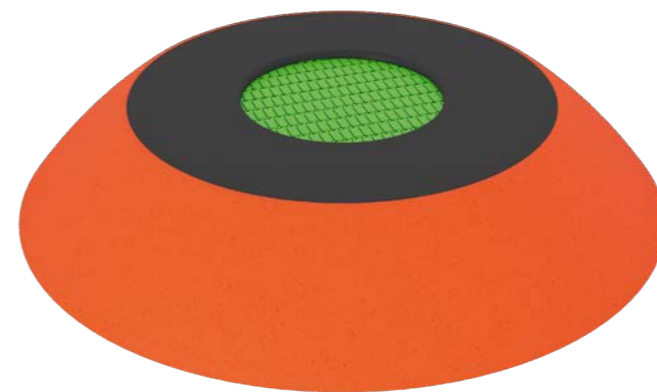

25.008

Trampoline Geoplasty square
1350x1350

width	length	height	fall height
2 050 mm	2 050 mm	310 mm	900 mm

Age range: 3-12 years

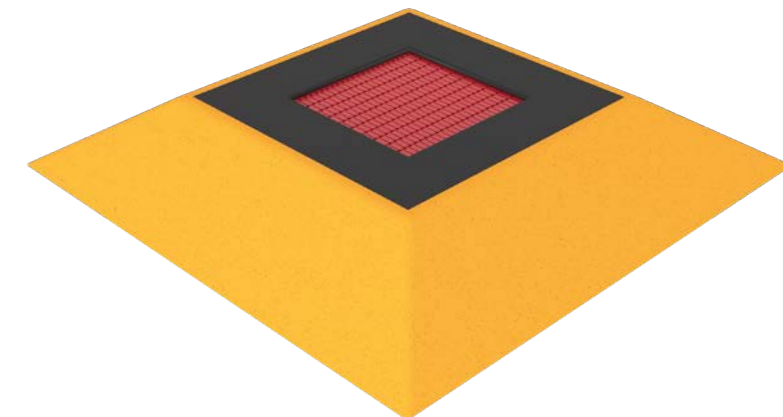
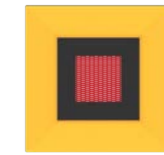

25.007

Trampoline Geoplasty round d = 1600

width	length	height	fall height
2 330 mm	2 330 mm	410 mm	900 mm

Age range: 3-12 years

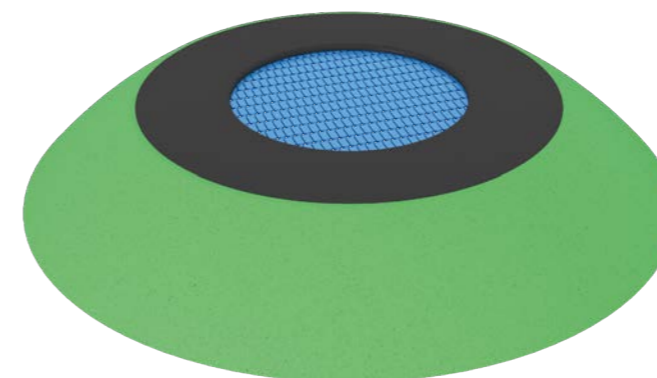

25.006

Trampoline Geoplasty octagonal
1600x1600mm

width	length	height	fall height
2 350 mm	2 350 mm	340 mm	900 mm

Age range: 3-12 years

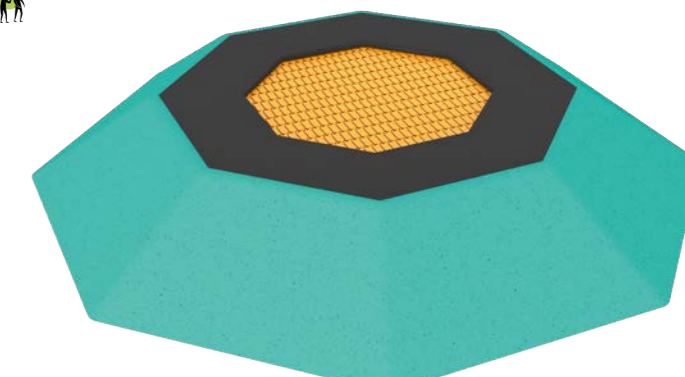

43.041

Sphere with rope

width	length	height	fall height
7 500 mm	4 500 mm	1 700 mm	-

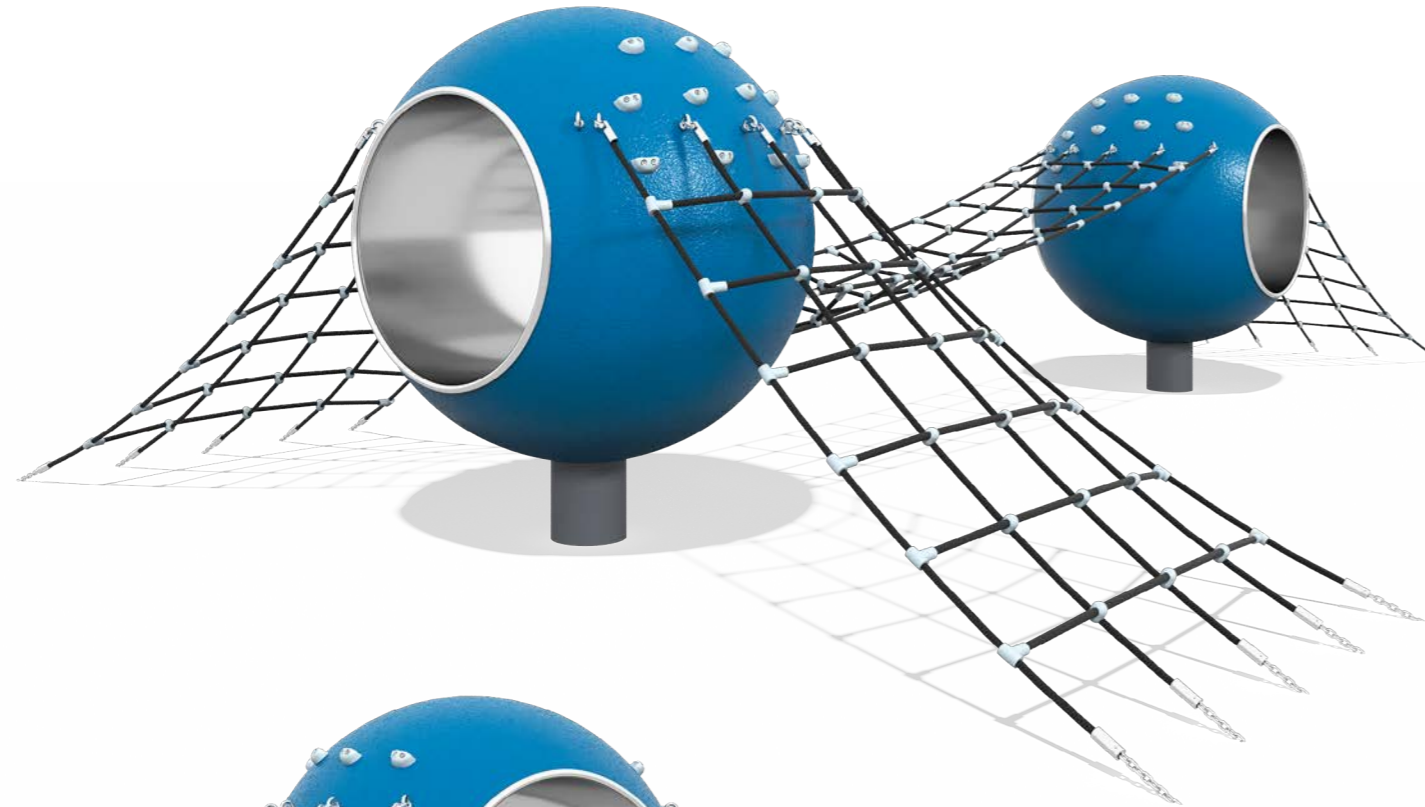

43.040

Sphere with rope

width	length	height	fall height
4 500 mm	4 500 mm	1 700 mm	-

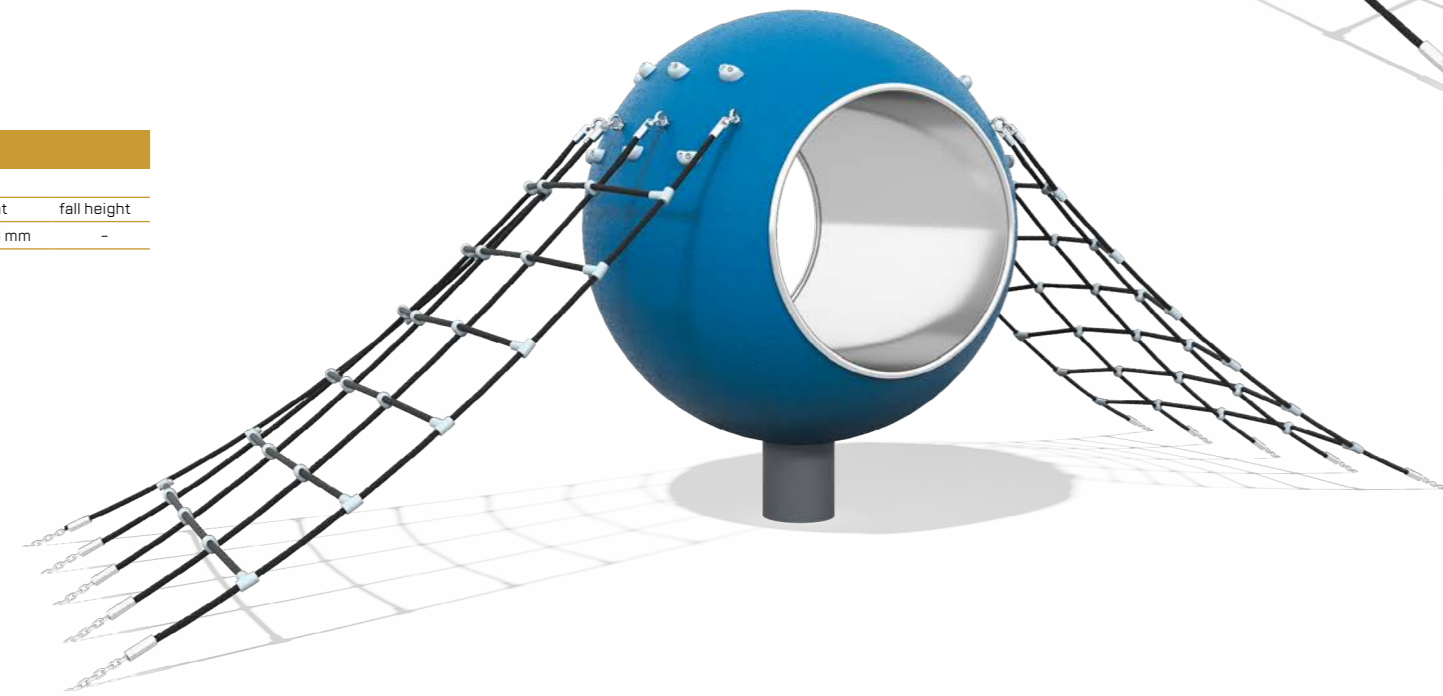

43.038

Bumps

width	length	height	fall height
2 350 mm	2 350 mm	750 mm	-



43.033

Hummock

width	length	height	fall height
400 mm	400 mm	120 mm	-



43.039

Sphere with rope

width	length	height	fall height
4 500 mm	4 500 mm	1 700 mm	-

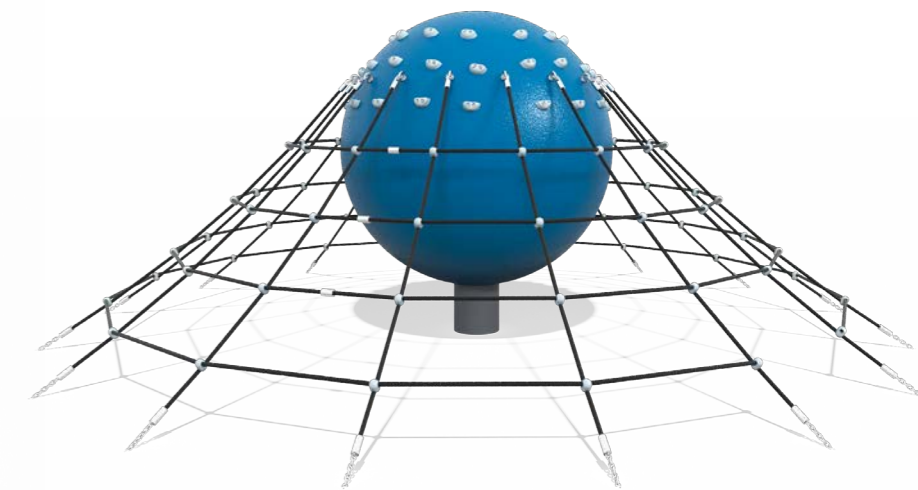

43.037

Hemisphere with a tunnel

width	length	height	fall height
1 500 mm	1 500 mm	750 mm	-

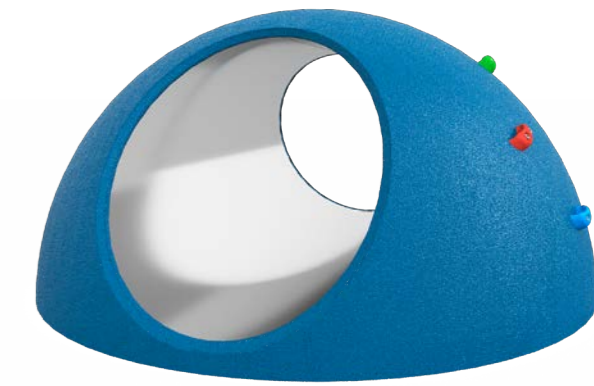

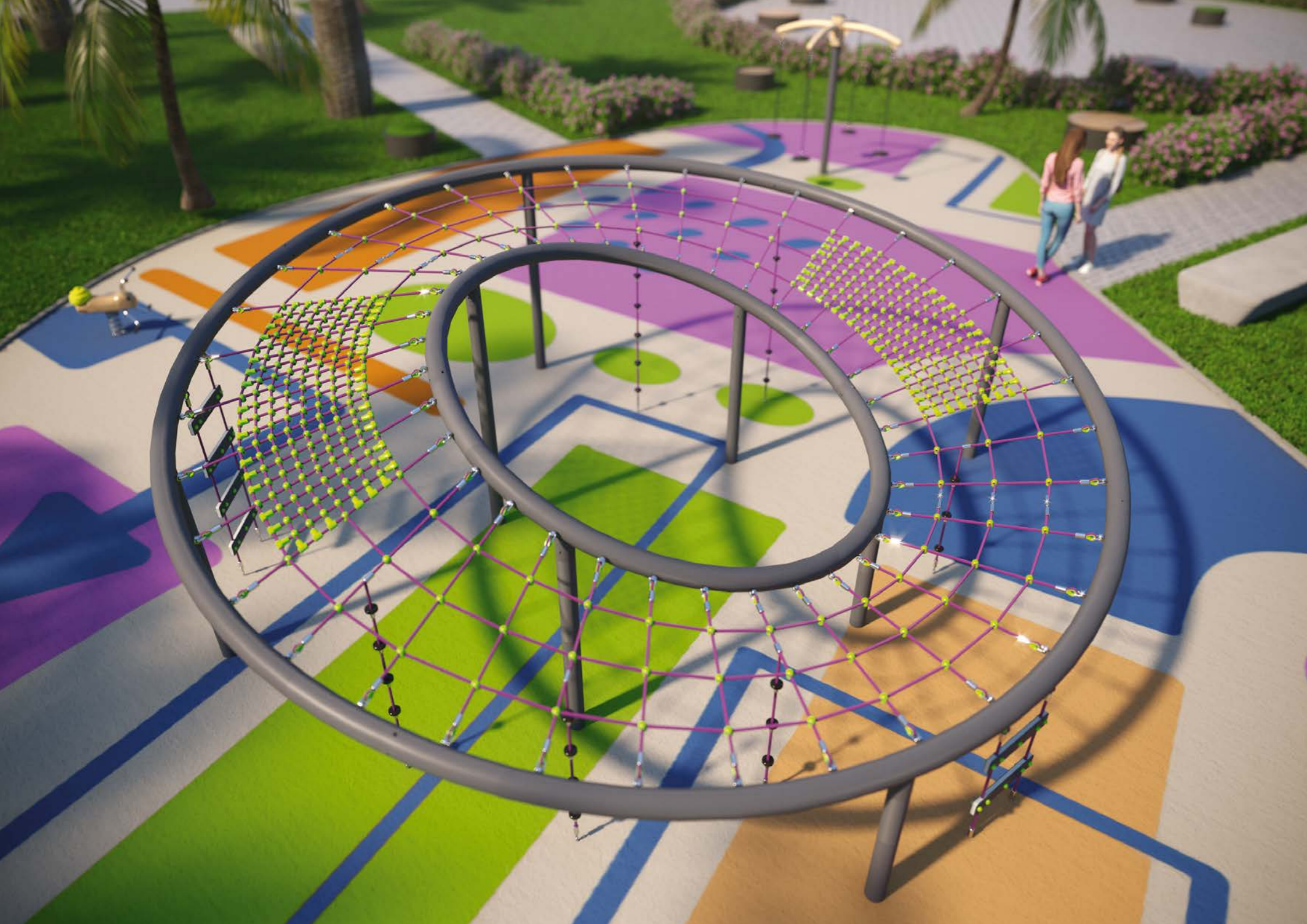

ROPE CLIMBING PLAYGROUNDS

21.041

Rope Climbing Playground Hydra

width	length	height	fall height
4 000 mm	24 300 mm	2 810 mm	1 390 mm

Age range: 7-12 years

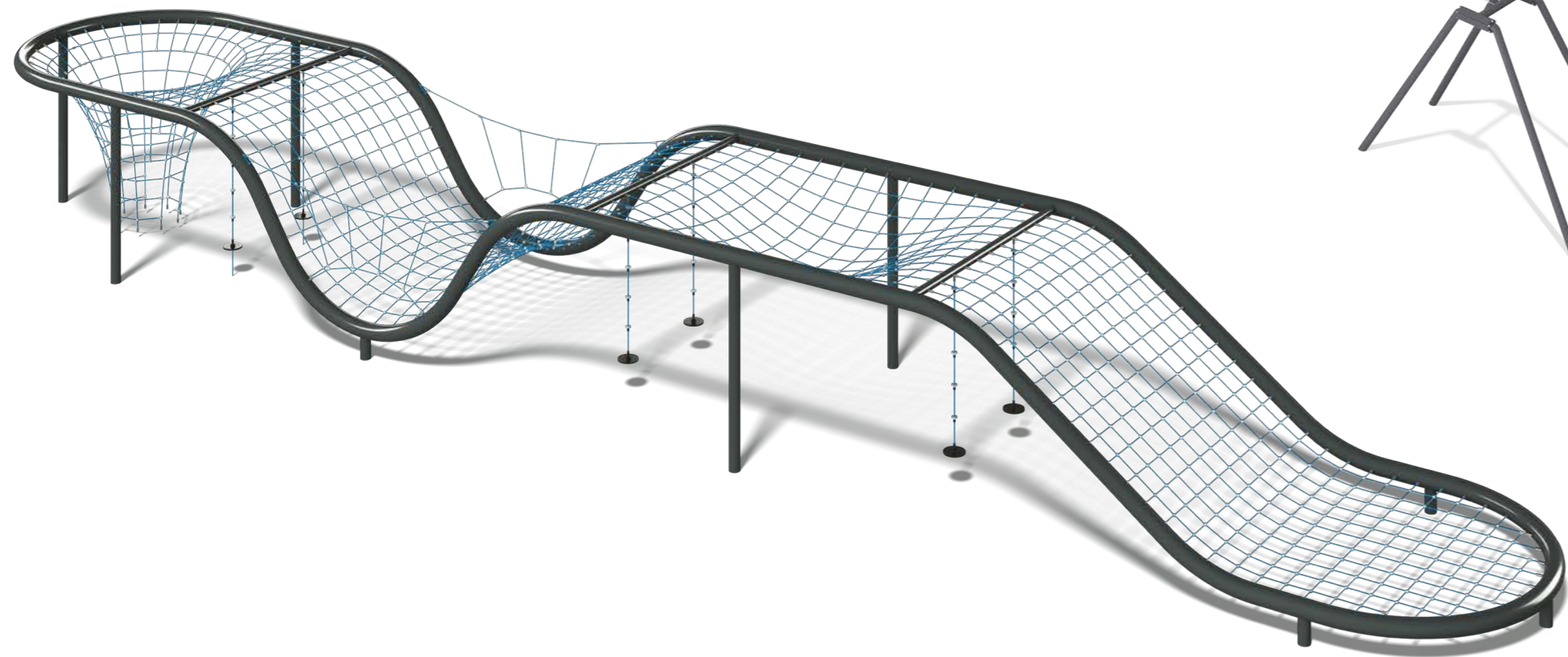

21.043

Rope Climbing Playground Cable car

width	length	height	fall height
2 323 mm	25 266 mm	3 937 mm	800 mm

Age range: 7-12 years



21.027

Rope Climbing Playground Olympus

width	length	height	fall height
4 600 mm	4 600 mm	2 800 mm	1 400 mm

Age range: 7-12 years

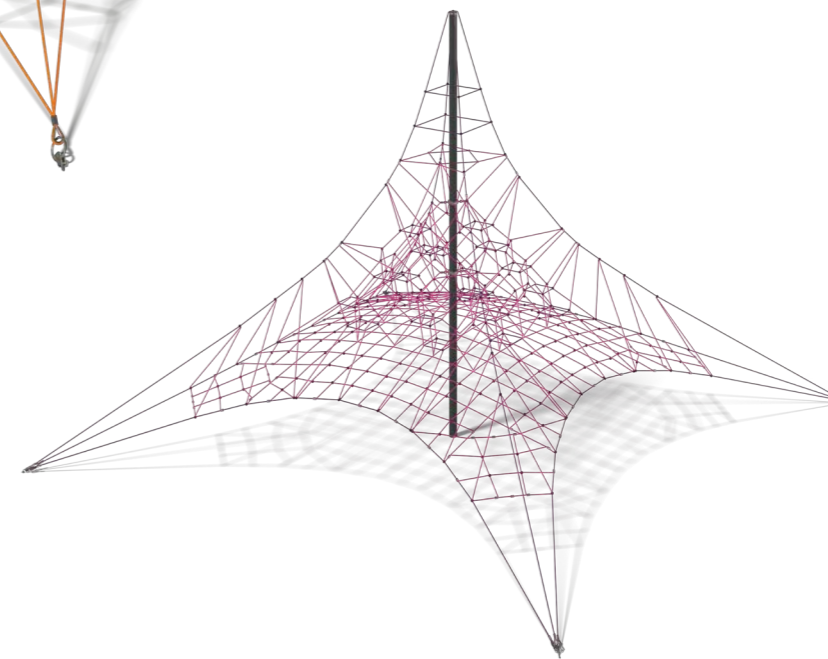
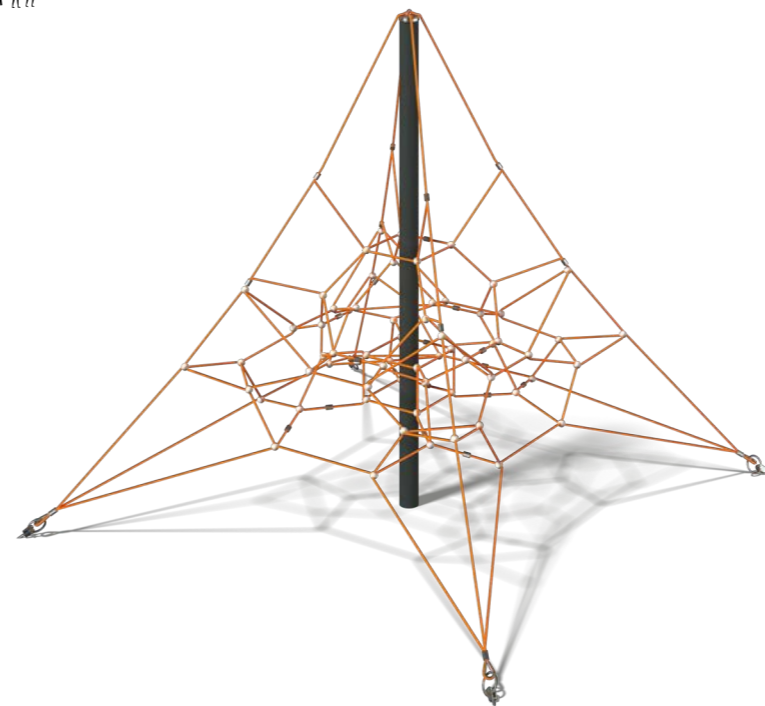

21.025

Rope Climbing Playground Fuji

width	length	height	fall height
7 700 mm	7 700 mm	4 000 mm	2 750 mm

Age range: 7-12 years

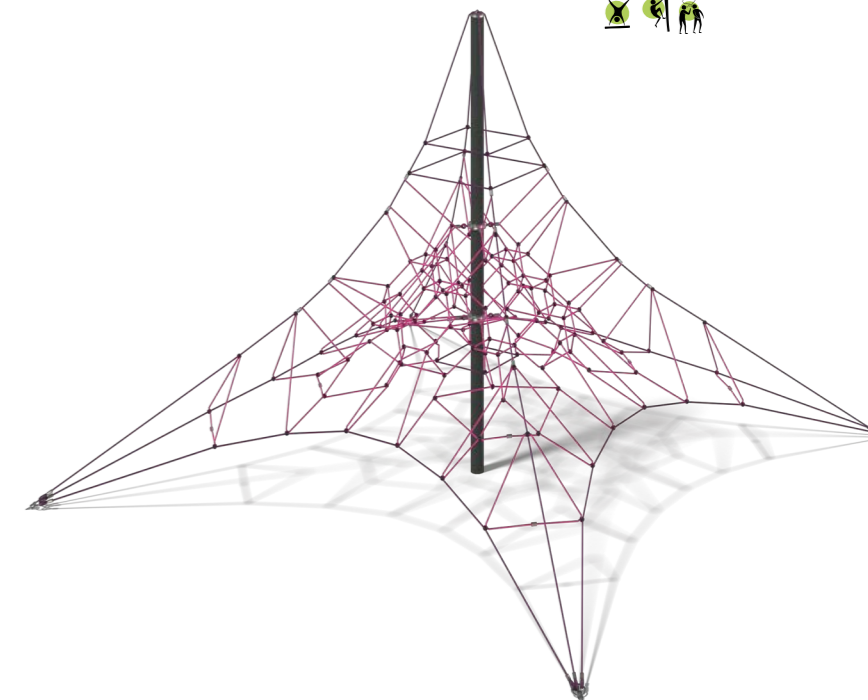

21.034

Rope Climbing Playground Himalayas

width	length	height	fall height
13 700 mm	13 700 mm	6 895 mm	-

Age range: 7-12 years



21.036**Rope Climbing Playground Pilyugin**

width	length	height	fall height
10 300 mm	10 300 mm	2 800 mm	990 mm

Age range: 7-12 years

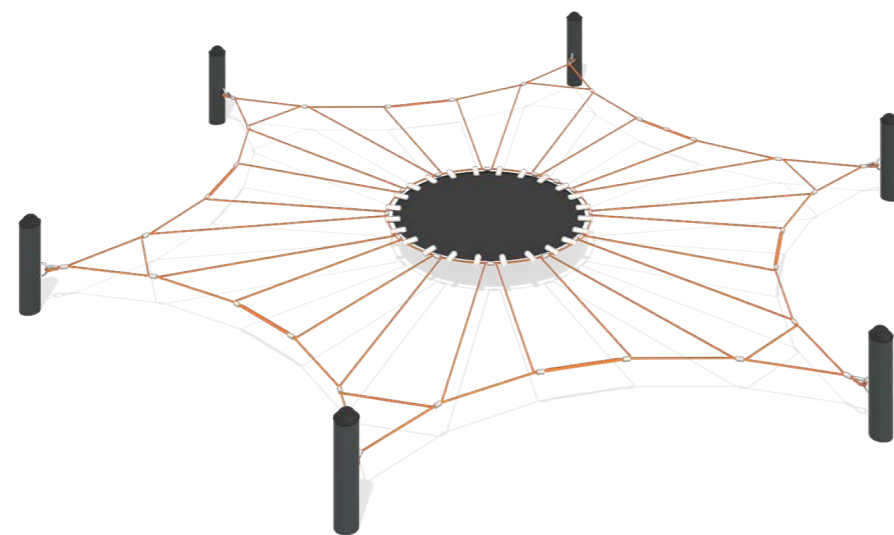
**21.065****Rope Climbing Playground Zander**

width	length	height	fall height
2 598 mm	3 000 mm	2 460 mm	1 615 mm

Age range: 7-12 years

**21.044****Rope Climbing Playground Baikonur**

width	length	height	fall height
6 110 mm	5 320 mm	850 mm	550 mm

Age range: 7-12 years

**21.067****Rope Climbing Playground Wrangel**

width	length	height	fall height
133 mm	3 133 mm	2 500 mm	2 500 mm

Age range: 7-12 years

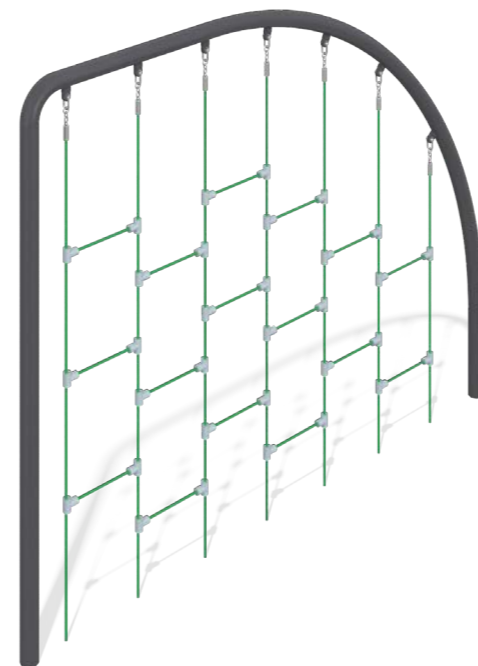
**21.069****Rope Climbing Playground Kunashir**

width	length	height	fall height
1 000 mm	3 000 mm	2 486 mm	1 590 mm

Age range: 7-12 years

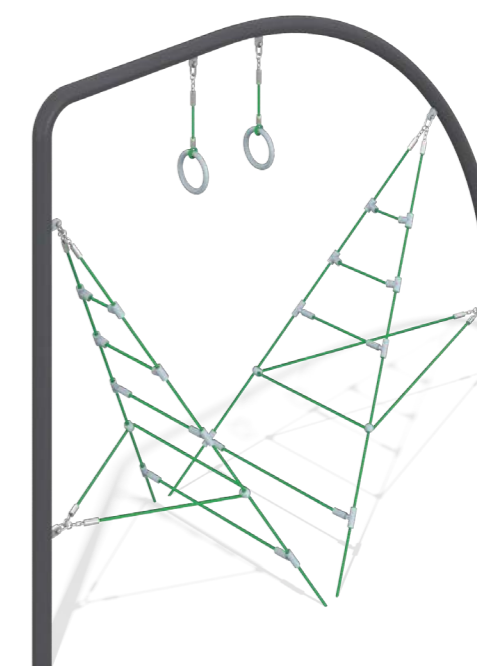
**21.058****Rope Climbing Playground Bering**

width	length	height	fall height
208 mm	3 056 mm	2 500 mm	1 680 mm

Age range: 7-12 years



21.064**Rope Climbing Playground Newton**

width	length	height	fall height
208 mm	3 188 mm	2 051 mm	399 mm

Age range: 7-12 years

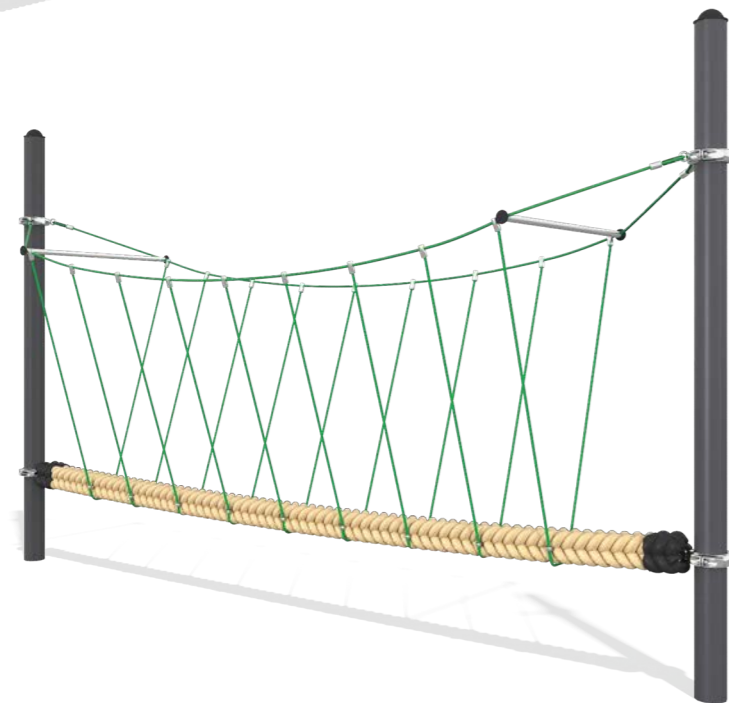
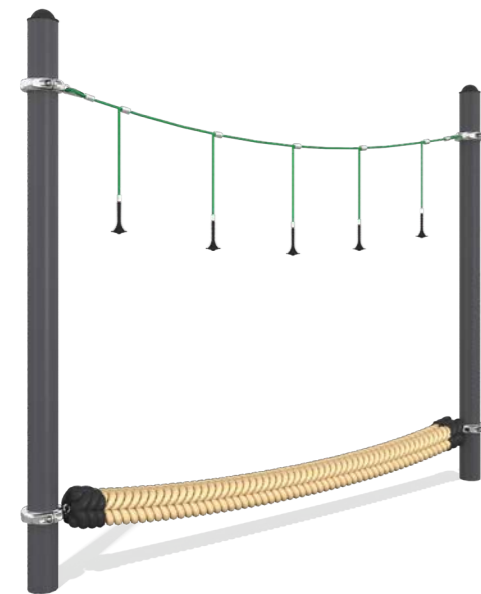
**21.052****Rope Climbing Playground Voltaire**

width	length	height	fall height
208 mm	3 190 mm	2 053 mm	410 mm

Age range: 7-12 years

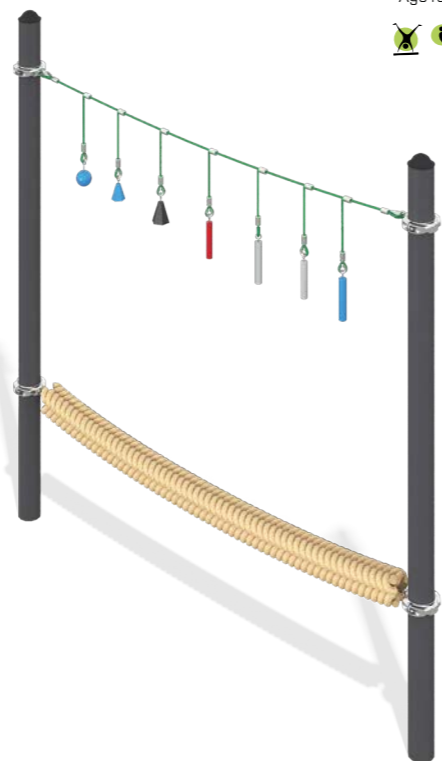
**21.066****Rope Climbing Playground Descartes**

width	length	height	fall height
1 150 mm	4 500 mm	2 303 mm	360 mm

Age range: 7-12 years

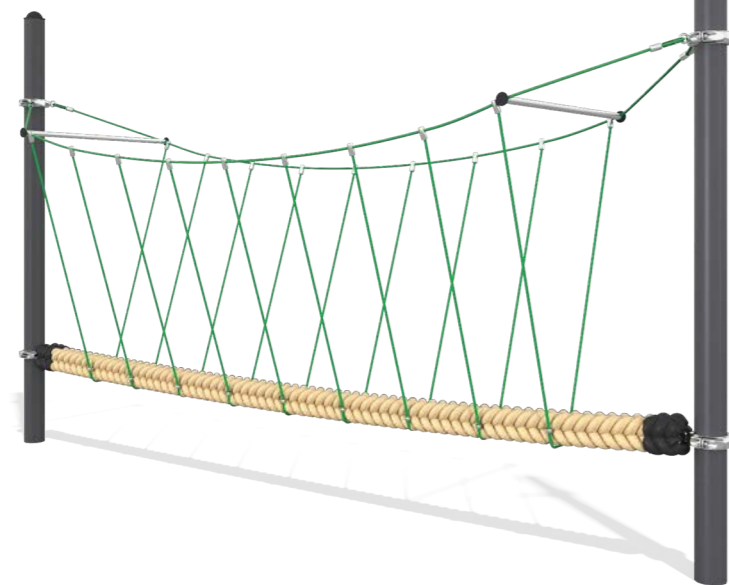
**21.068****Rope Climbing Playground Copernicus**

width	length	height	fall height
1 100 mm	6 000 mm	3 000 mm	380 mm

Age range: 7-12 years

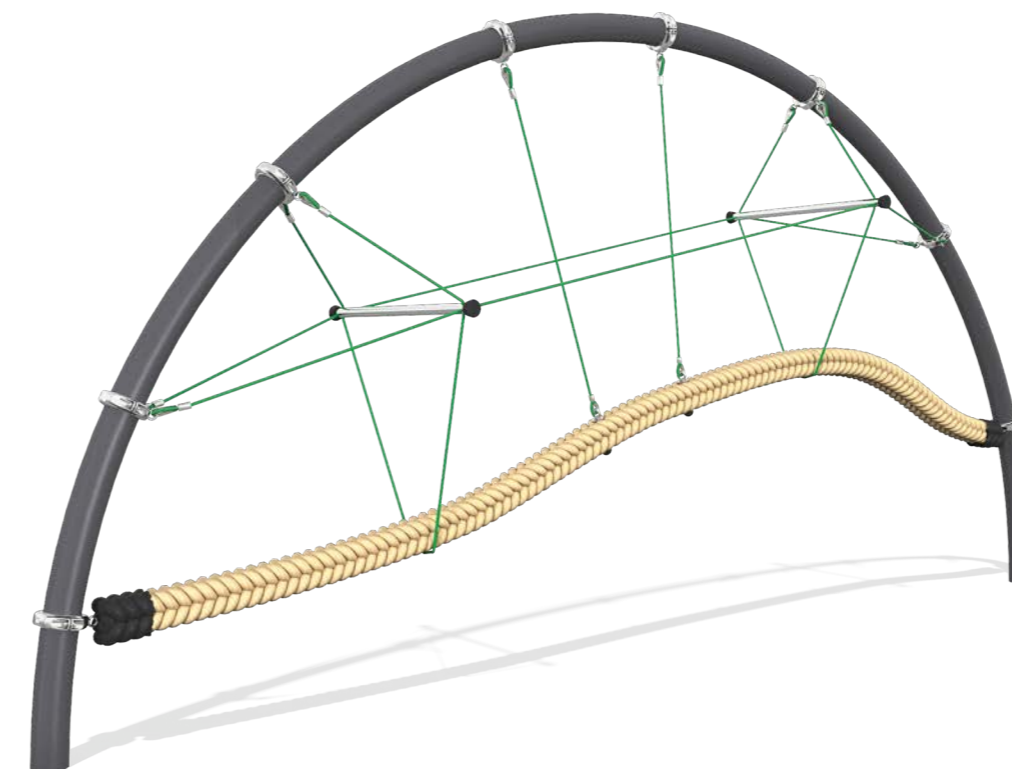
**21.062****Rope Climbing Playground Foucault**

width	length	height	fall height
4 853 mm	4 855 mm	2 780 mm	595 mm

Age range: 7-12 years

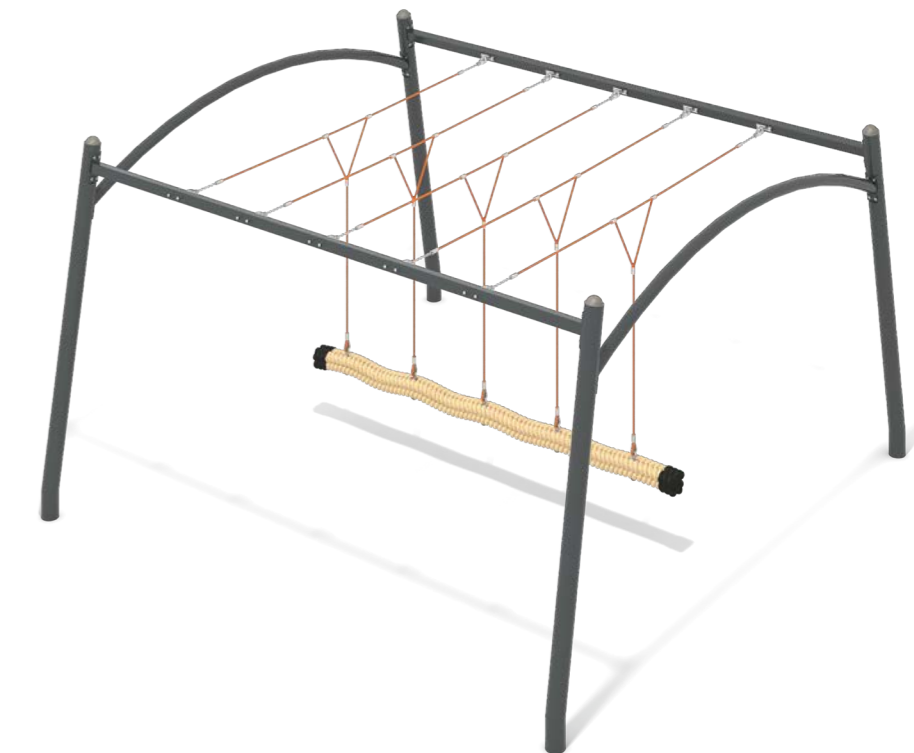

21.038**Rope Climbing Playground Montblan**

width	length	height	fall height
6 830 mm	6 830 mm	3 935 mm	1 460 mm

Age range: 7-12 years

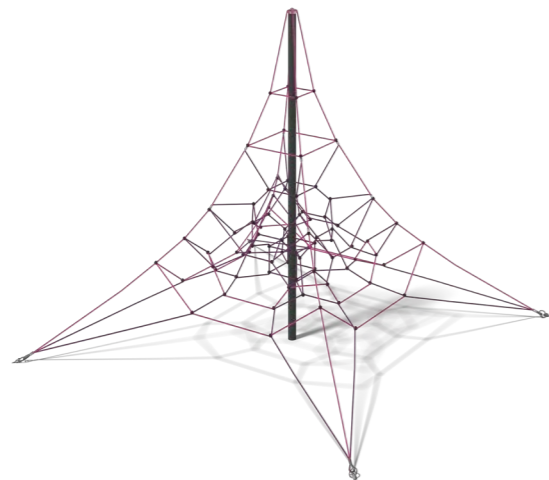
**21.023****Rope Climbing Playground Andes**

width	length	height	fall height
4 175 mm	4 820 mm	2 960 mm	1 350 mm

Age range: 7-12 years

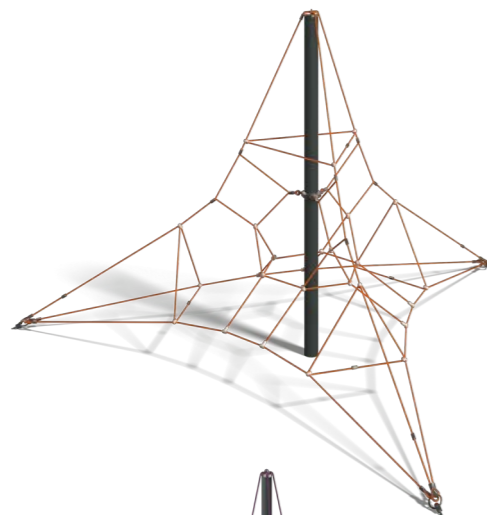
**21.030****Rope Climbing Playground Everest**

width	length	height	fall height
6 700 mm	6 700 mm	3 600 mm	2 700 mm

Age range: 7-12 years

**21.029****Rope Climbing Playground Tibet**

width	length	height	fall height
3 470 mm	4 000 mm	3 000 mm	1 830 mm

Age range: 7-12 years

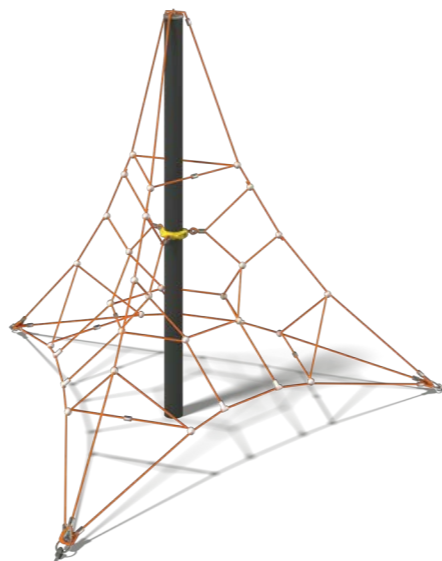
**21.028****Rope Climbing Playground Rashmore**

width	length	height	fall height
5 310 mm	5 310 mm	2 840 mm	1 246 mm

Age range: 7-12 years

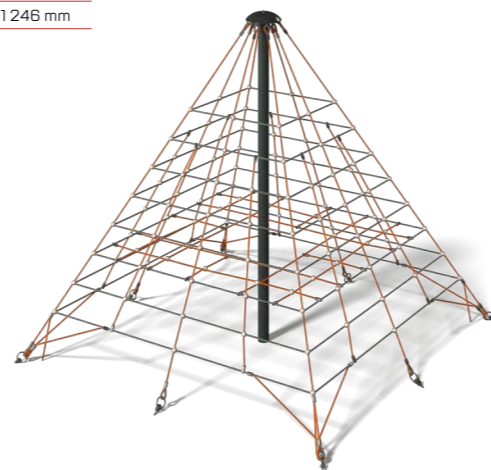
**21.042****Rope Climbing Playground Lagrange**

width	length	height	fall height
5 060 mm	5 060 mm	2 700 mm	2 700 mm

Age range: 7-12 years

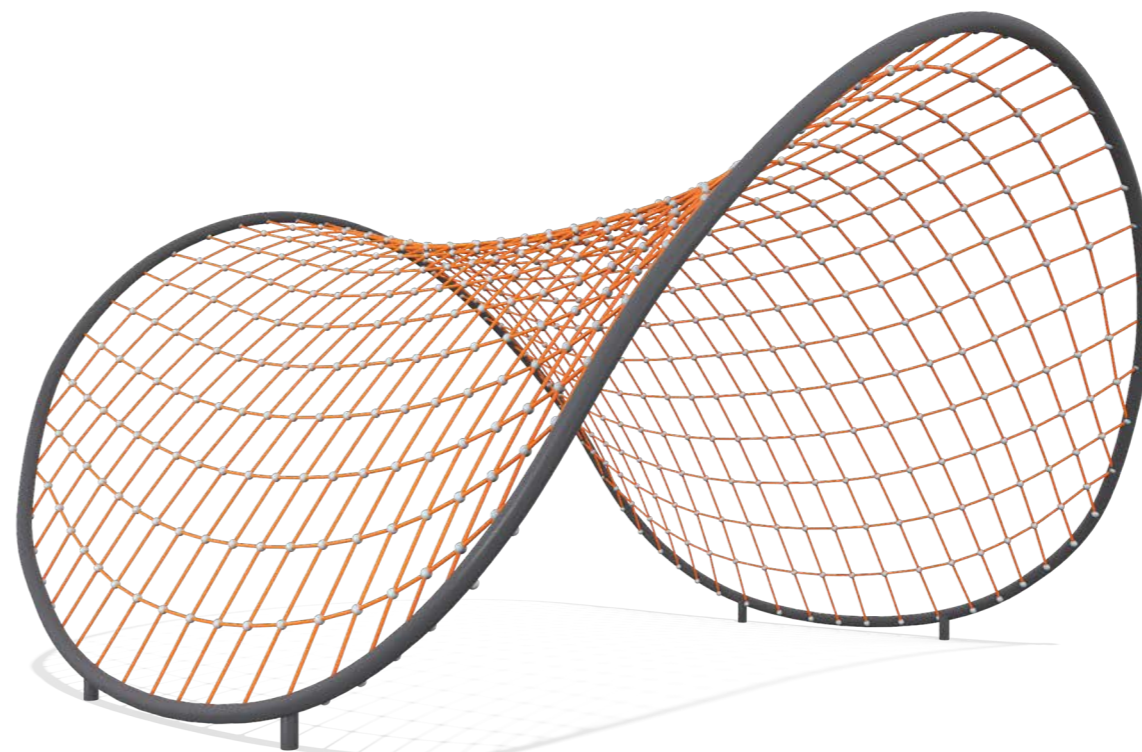
**21.026****Rope Climbing Playground Leibniz**

width	length	height	fall height
4 490 mm	4 490 mm	3 480 mm	1 670 mm

Age range: 7-12 years

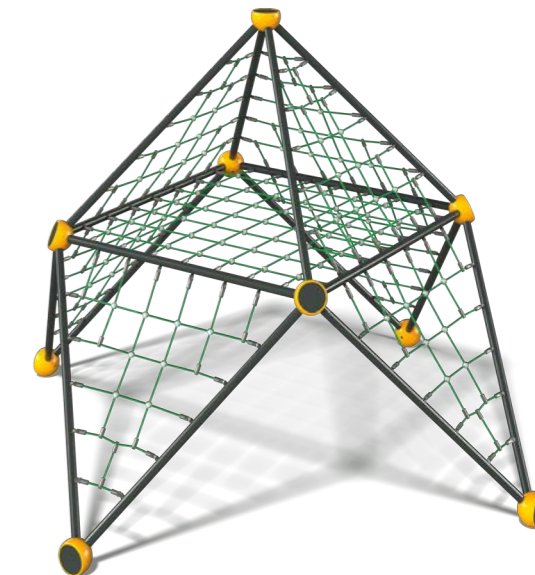
**21.039****Rope Climbing Playground Serpinsky**

width	length	height	fall height
4 610 mm	4 610 mm	3 498 mm	1 687 mm

Age range: 7-12 years

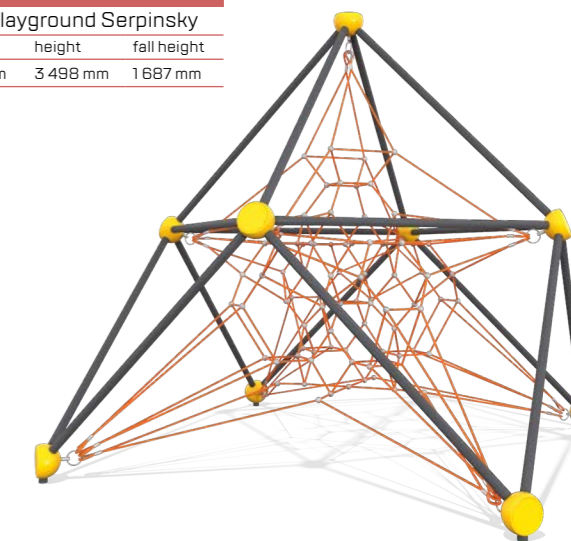

21.032**Rope Climbing Playground Minkovsky**

width	length	height	fall height
4 490 mm	4 490 mm	4 120 mm	2 520 mm

Age range: 7-12 years

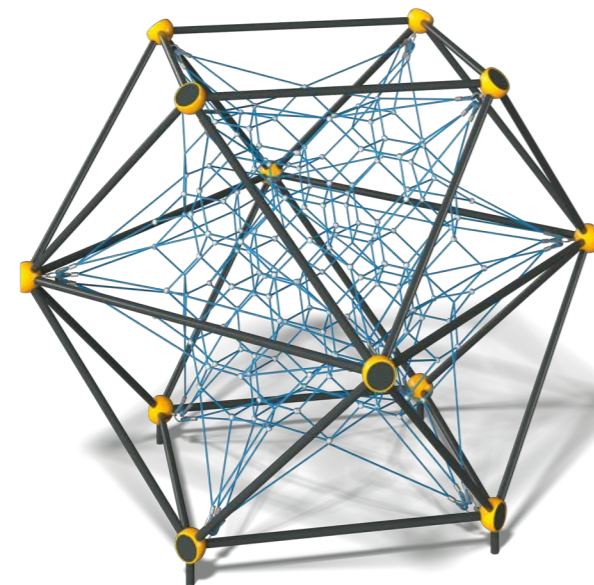
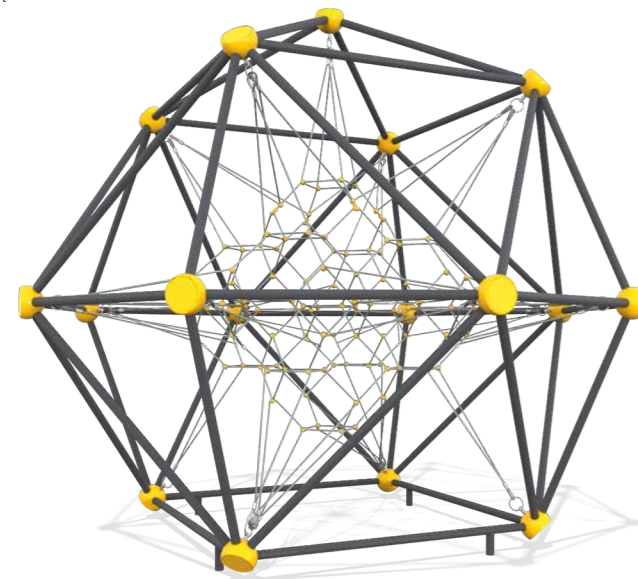
**21.047****Rope Climbing Playground Saharov**

width	length	height	fall height
3 740 mm	4 235 mm	3 735 mm	2 481 mm

Age range: 7-12 years

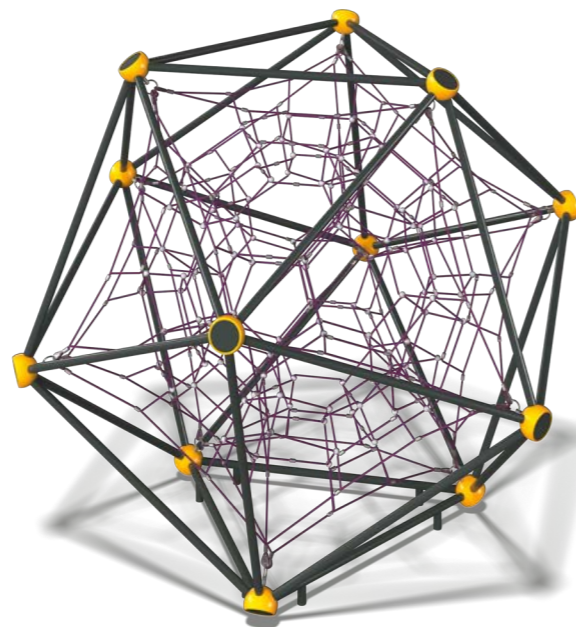
**21.013****Rope Climbing Playground Mendeleev**

width	length	height	fall height
4 490 mm	4 490 mm	3 550 mm	1 880 mm

Age range: 7-12 years

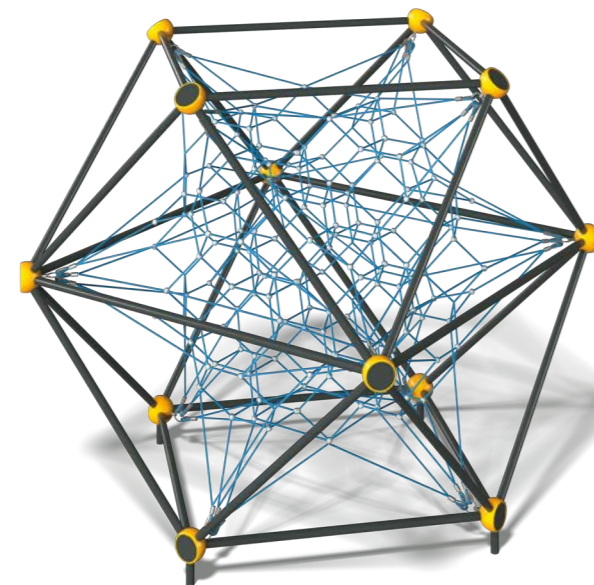
**21.045****Rope Climbing Playground Carbon**

width	length	height	fall height
4 500 mm	4 500 mm	2 170 mm	1 280 mm

Age range: 7-12 years

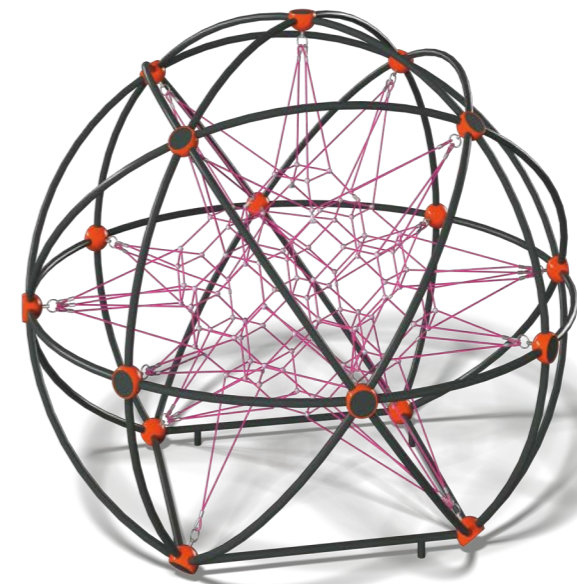
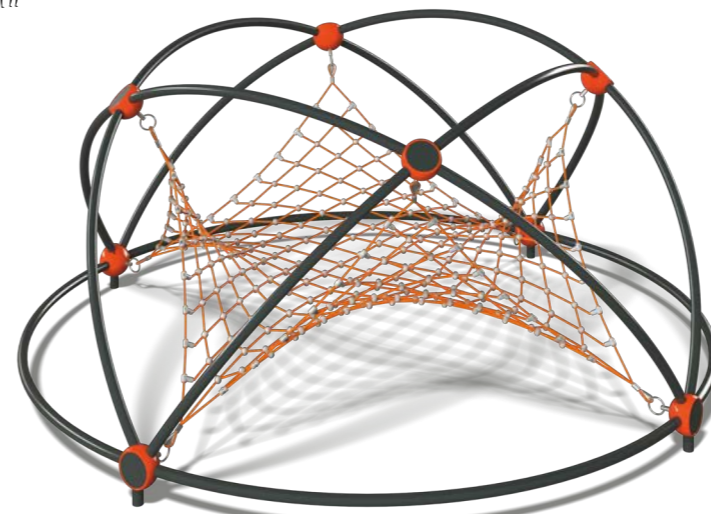
**21.033****Rope Climbing Playground Euler**

width	length	height	fall height
5 620 mm	5 620 mm	4 730 mm	2 730 mm

Age range: 7-12 years

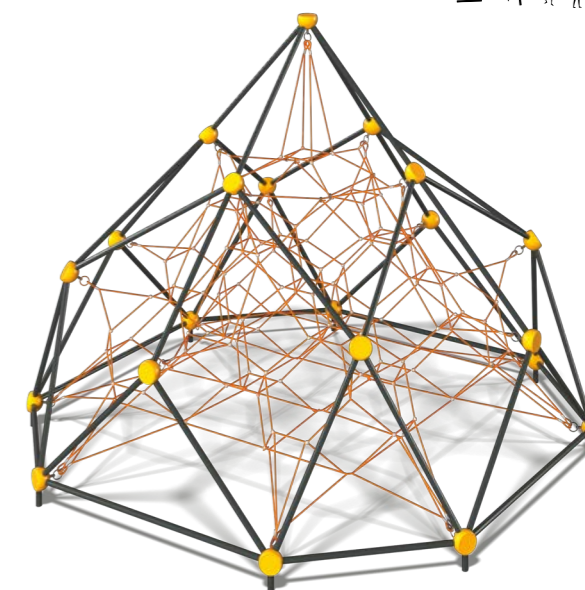
**21.024****Rope Climbing Playground Silicon**

width	length	height	fall height
4 500 mm	4 500 mm	4 140 mm	2 450 mm

Age range: 7-12 years

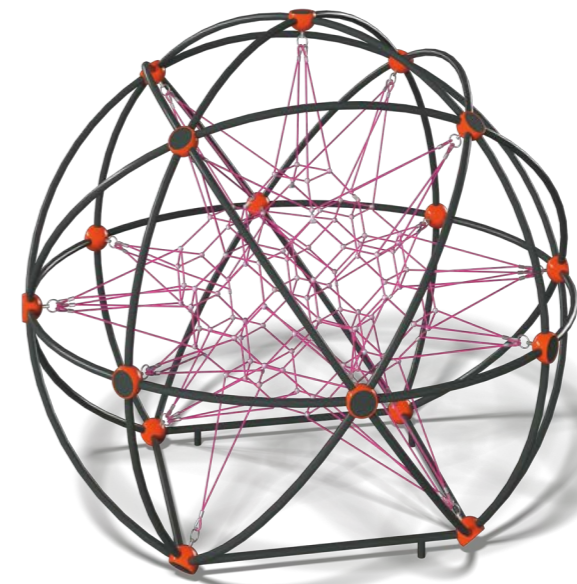



STREET WORKOUT

26.034

Workout System

width	length	height	fall height
3 746 mm	10 507 mm	2 554 mm	-

Age range: 14+

**26.057**

Workout System

width	length	height	fall height
1 358 mm	3 450 mm	2 554 mm	-

Age range: 14+

**26.033**

Workout System

width	length	height	fall height
3 746 mm	6 375 mm	2 554 mm	-

Age range: 14+

**26.006**

Workout System

width	length	height	fall height
1 358 mm	2 242 mm	2 554 mm	-

Age range: 14+

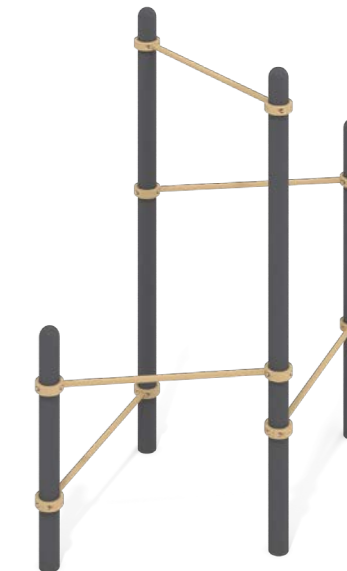
**26.047**

Workout System

width	length	height	fall height
3 166 mm	6 903 mm	2 554 mm	-

Age range: 14+

**26.032**

Workout System

width	length	height	fall height
1 926 mm	6 646 mm	2 554 mm	-

Age range: 14+

**26.049**

Workout System

width	length	height	fall height
2 955 mm	3 420 mm	2 554 mm	-

Age range: 14+



26.053

Workout System

width	length	height	fall height
2 955 mm	6 190 mm	2 554 mm	-

Age range: 14+



26.003

Workout System Classic double-levelled

width	length	height	fall height
1 358 mm	6 646 mm	2 554 mm	-

Age range: 14+



26.054

Workout System

width	length	height	fall height
3 512 mm	3 774 mm	2 554 mm	-

Age range: 14+

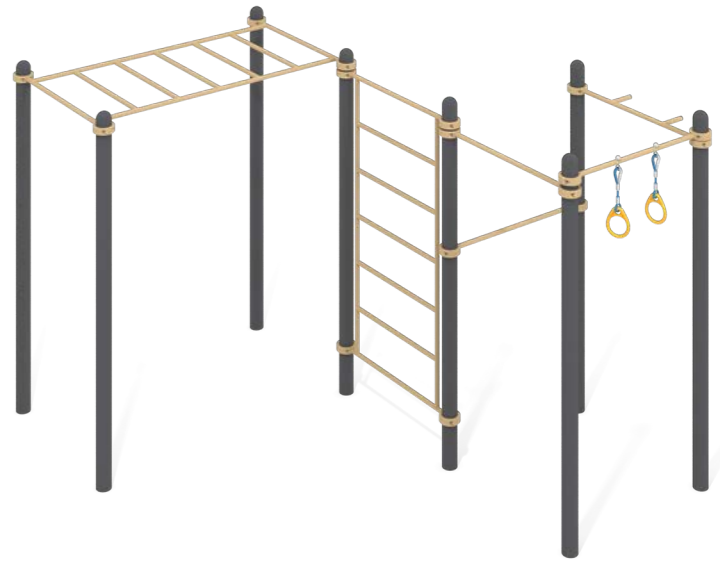

26.024

Workout System 5 Pullups and AB bench

width	length	height	fall height
2 955 mm	4 982 mm	2 554 mm	-

Age range: 14+



26.002

Workout System Snake hand-walker Swedish wall and Pullups

width	length	height	fall height
1 694 mm	5 682 mm	2 554 mm	-

Age range: 14+

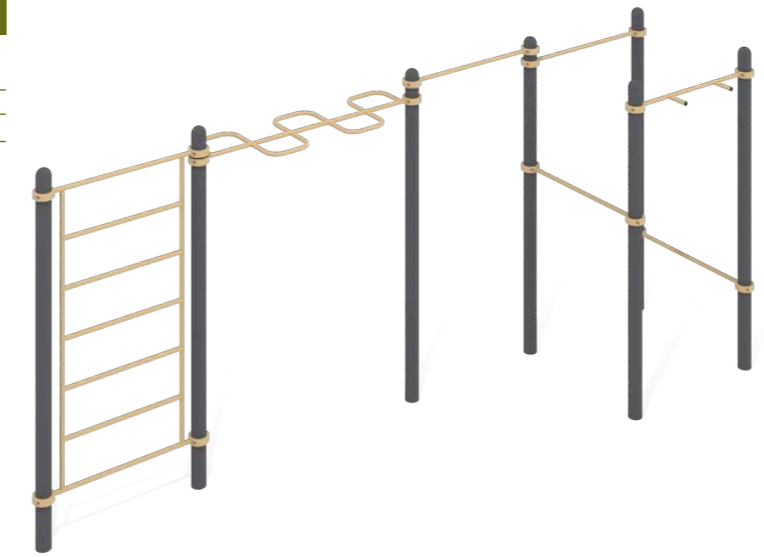

26.027

Workout System Classic hand walker

width	length	height	fall height
1 468 mm	4 340 mm	2 605 mm	-

Age range: 14+

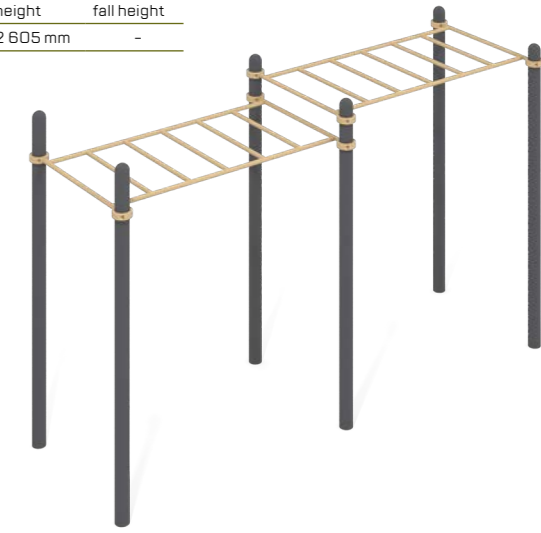

26.025

Workout System Double bars for push-ups

width	length	height	fall height
860 mm	2 676 mm	1 555 mm	-

Age range: 14+



26.028

Workout System

width	length	height	fall height
750 mm	1 358 mm	1 554 mm	-

Age range: 14+



26.052

Workout System Pillars

width	length	height	fall height
108 mm	808 mm	2 054 mm	-

Age range: 14+



26.005

Workout System AB bench

width	length	height	fall height
1 466 mm	1 693 mm	1 245 mm	-

Age range: 14+



26.004

Bench For rest

width	length	height	fall height
758 mm	1 635 mm	554 mm	-

Age range: 14+



26.046

Workout System Detent

width	length	height	fall height
850 mm	2 000 mm	700 mm	-

Age range: 14+

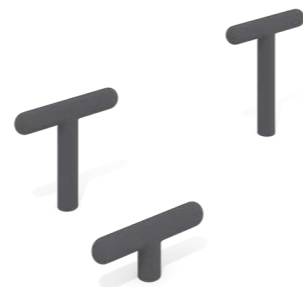

26.051

Workout System Classic Pullup

width	length	height	fall height
150 mm	1 358 mm	2 554 mm	-

Age range: 14+



26.055

Workout System Multi-levelled double Pullup

width	length	height	fall height
260 mm	2 676 mm	2 605 mm	-

Age range: 14+



26.058

Workout System Triple cascade

width	length	height	fall height
150 mm	3 774 mm	2 554 mm	-

Age range: 14+

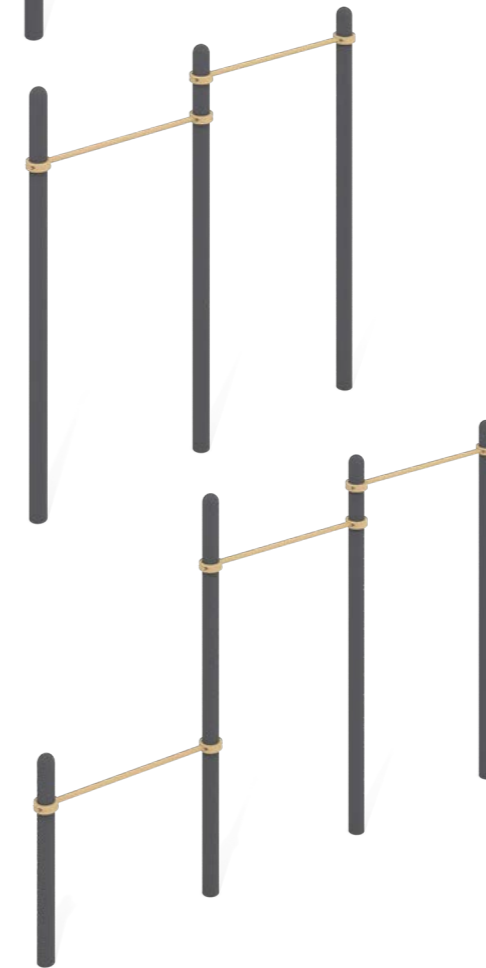

26.030

Workout System Snake hand-walker

width	length	height	fall height
577 mm	2 058 mm	2 554 mm	-

Age range: 14+

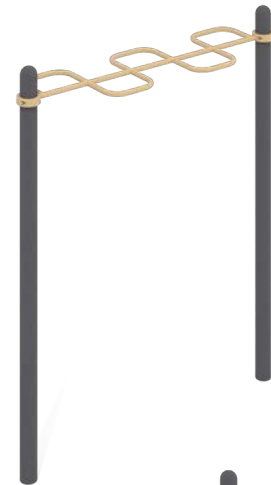

26.050

Workout System Swedish wall

width	length	height	fall height
150 mm	1 358 mm	2 554 mm	-

Age range: 14+



26.056

Workout System Multi-levelled triple

width	length	height	fall height
1 196 mm	1 358 mm	2 554 mm	-

Age range: 14+

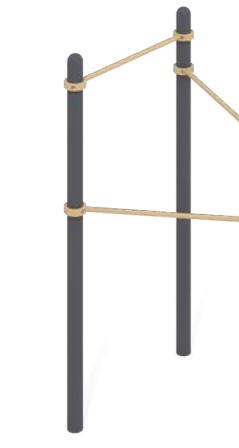

26.059

Workout System

width	length	height	fall height
5 582 mm	6 190 mm	2 554 mm	-

Age range: 14+



26.008

Workout System

width	length	height	fall height
1 893 mm	4 374 mm	2 554 mm	-

Age range: 14+



26.007

Workout System

width	length	height	fall height
1 893 mm	3 774 mm	2 554 mm	-

Age range: 14+



26.026

Workout System Stop with stops for push-up

width	length	height	fall height
482 mm	2 382 mm	963 mm	-

Age range: 14+



26.013

Workout System Parallel Bars

width	length	height	fall height
600 mm	2 040 mm	1 202 mm	-

Age range: 14+



26.029

Workout System

width	length	height	fall height
2 955 mm	3 166 mm	2 554 mm	-

Age range: 14+



26.022

Workout System

width	length	height	fall height
2 955 mm	3 774 mm	2 554 mm	-

Age range: 14+

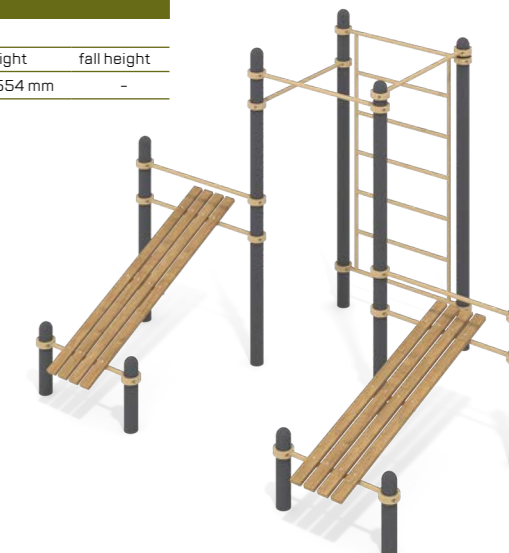



FITNESS STATIONS

31.036

Fitness Station Elipse

width	length	height	fall height
650 mm	1650 mm	1550 mm	-

Age range: 14+

**31.016**

Fitness Station Exercycle

width	length	height	fall height
530 mm	1300 mm	1200 mm	-

Age range: 14+

**31.015**

Fitness Station Eco Bars

width	length	height	fall height
730 mm	1550 mm	1600 mm	1300 mm

Age range: 14+

**31.017**

Fitness Station Pendulum

width	length	height	fall height
400 mm	1080 mm	1550 mm	-

Age range: 14+

**31.018**

Fitness Station Craving from above

width	length	height	fall height
1000 mm	1000 mm	1900 mm	-

Age range: 14+

**31.020**

Fitness Station Air walker

width	length	height	fall height
500 mm	1100 mm	1650 mm	-

Age range: 14+

**MG4532**

Sports equipment for workout

width	length	height	fall height
1720 mm	6430 mm	2800 mm	-

Age range: 14+

**MG4535**

Sports equipment for workout

width	length	height	fall height
7040 mm	7960 mm	3050 mm	-

Age range: 14+

**MG4511**

Sports system Bench with stops

width	length	height	fall height
1320 mm	2440 mm	990 mm	-

Age range: 14+

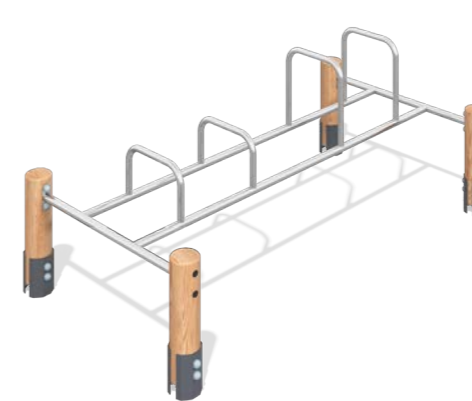
**MG4516**

Sports system Handlebar

width	length	height	fall height
1680 mm	2295 mm	2050 mm	1950 mm

Age range: 14+

**MG4504**

Sports system Horizontal bar tee low

width	length	height	fall height
190 mm	4730 mm	1550 mm	-

Age range: 14+

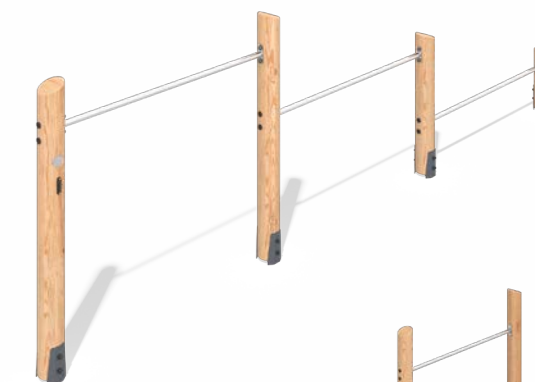
**MG4502**

Sports system Double horizontal bar

width	length	height	fall height
190 mm	3200 mm	2800 mm	-

Age range: 14+



31.009

Fitness Station Double Pullup

width	length	height	fall height
80 mm	2 580 mm	2 503 mm	-

Age range: 12+

**31.010**

Fitness Station Triple Pullup

width	length	height	fall height
80 mm	3 870 mm	2 500 mm	-

Age range: 12+

**31.011**

Fitness Station Gymnastic rings

width	length	height	fall height
80 mm	1 330 mm	2 500 mm	-

Age range: 12+

**31.005**

Fitness Station Gymnastic rope

width	length	height	fall height
80 mm	1 330 mm	2 500 mm	-

Age range: 12+

**31.003**

Fitness Station Classic Pullup

width	length	height	fall height
80 mm	1 373 mm	2 503 mm	-

Age range: 12+

**31.001**

Fitness Station Pullups

width	length	height	fall height
1 810 mm	2 580 mm	2 500 mm	-

Age range: 12+

**31.008**

Fitness Station Hand walker

width	length	height	fall height
1 210 mm	2 660 mm	2 503 mm	-

Age range: 12+

**31.002**

Fitness Station Gymnastic bars

width	length	height	fall height
760 mm	1 374 mm	1 505 mm	-

Age range: 12+

**31.006**

Fitness Station Classic Pullup for children's

width	length	height	fall height
80 mm	1 373 mm	1 803 mm	-

Age range: 12+

**31.004**

Fitness Station Press for push-ups

width	length	height	fall height
80 mm	1 373 mm	605 mm	-

Age range: 12+

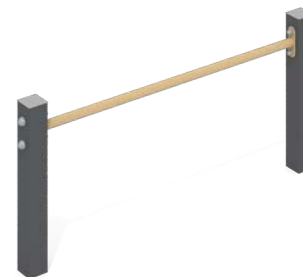



31.217

Fitness Station

width	length	height	fall height
3 383 mm	4 783 mm	3 096 mm	-

Age range: 14+



28.048

Sports complex with rings

width	length	height	fall height
1 300 mm	2 547 mm	2 736 mm	1 600 mm

Age range: 12+

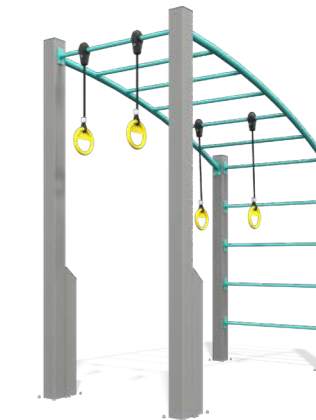

26.062

Double horizontal bar

width	length	height	fall height
244 mm	2 480 mm	2 436 mm	1 300 mm

Age range: 12+

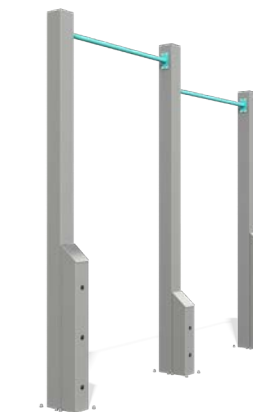

26.061

Bars

width	length	height	fall height
610 mm	1 503 mm	1 310 mm	1 200 mm

Age range: 5+

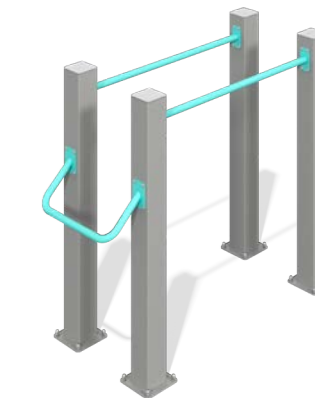

FS-21804Outdoor standard Adult
Fitness Equipment

width	length	height	fall height
520 mm	2 000 mm	1 350 mm	-

Age range: 5-12 years

**FS-21704**Outdoor standard Adult
Fitness Equipment

width	length	height	fall height
550 mm	990 mm	1 440 mm	-

Age range: 5-12 years

**FS-21701**Outdoor standard Adult
Fitness Equipment

width	length	height	fall height
360 mm	1 840 mm	1 650 mm	-

Age range: 5-12 years

**FS-21705**Outdoor standard Adult
Fitness Equipment

width	length	height	fall height
1 490 mm	1 490 mm	1 250 mm	-

Age range: 5-12 years

**FS-21703**Outdoor standard Adult
Fitness Equipment

width	length	height	fall height
1 740 mm	730 mm	2 250 mm	-

Age range: 5-12 years

**FS-21702**Outdoor standard Adult
Fitness Equipment

width	length	height	fall height
1 120 mm	890 mm	1 300 mm	-

Age range: 5-12 years

**31.039**

Fitness Station 502

width	length	height	fall height
5 210 mm	6 064 mm	2 416 mm	-

Age range: 12+

**31.007**Fitness Station Press, Pullup
and the Swedish wall

width	length	height	fall height
1 330 mm	1 760 mm	2 500 mm	-

Age range: 12+

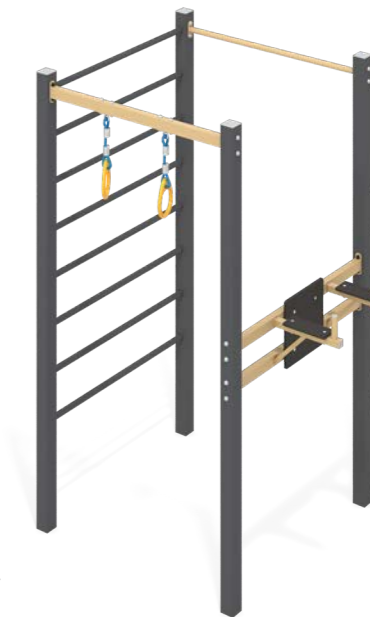
**31.065**

Fitness Station 503

width	length	height	fall height
5 071 mm	6 022 mm	3 495 mm	-

Age range: 12+



Designed to support healthy movement and daily activity, our outdoor fitness stations offer a versatile workout experience in the fresh air. From basic strength exercises to full-body training, they're suitable for all ages and ability levels.

All equipment is available in a wide range of colors to match your project's aesthetic. We can manufacture our fitness units — like any other product in our catalog — in the color of your choice. Just reach out to your manager for the full palette.



FENCING OF THE SPORTS GROUND MULTI USE GAME AREA

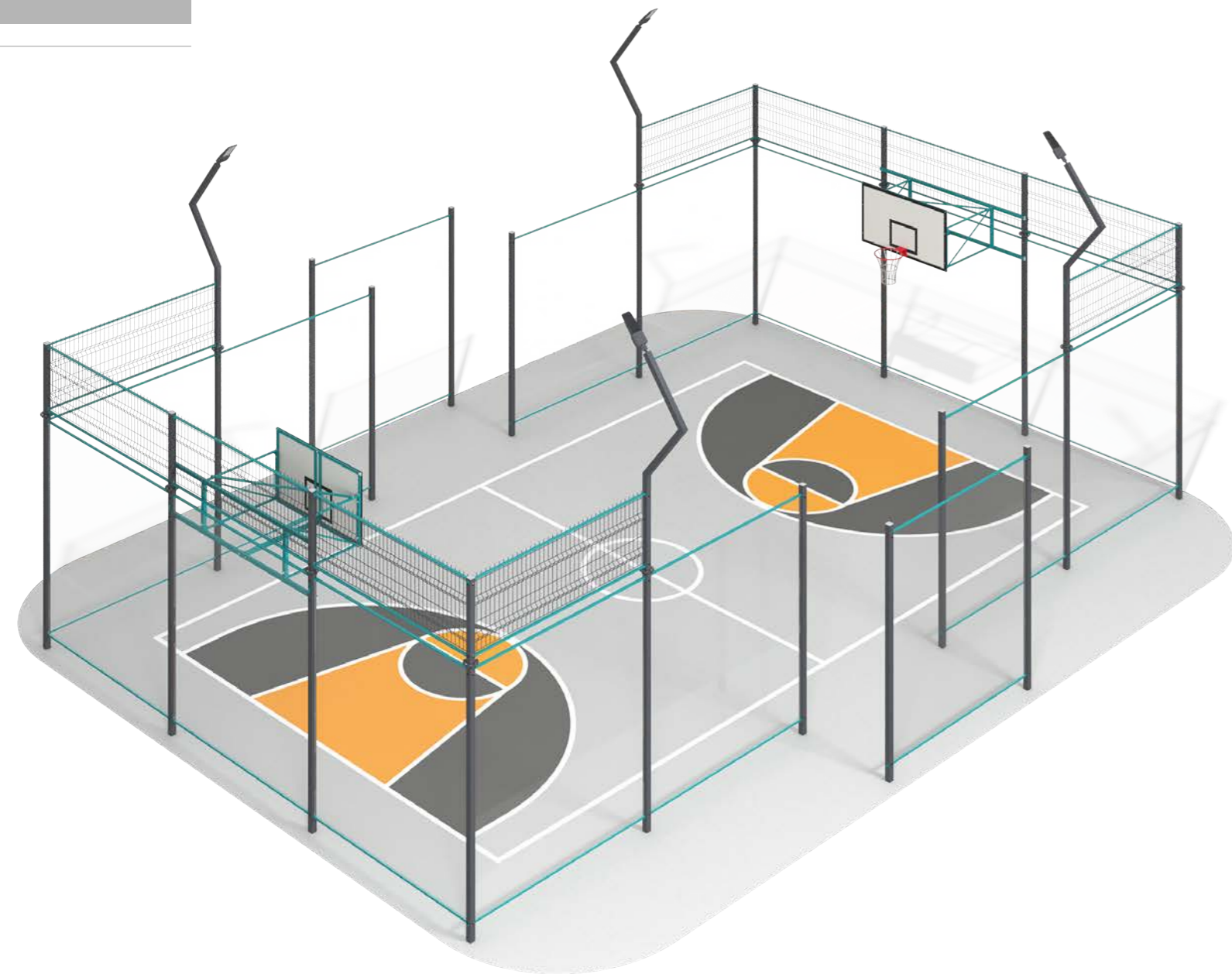

Multi use game areas (MUGA) are designed for hosting various games such as football, basketball, volleyball, tennis, badminton, and others. The size of the ready-made MUGA depends only on your needs, we will make it individually for you.



DOG AGILITY AREAS

35.015

Low hound hurdles

width	length	height	fall height
52 mm	1 000 mm	322 mm	-



35.013

Medium hound hurdles

width	length	height	fall height
55 mm	1 000 mm	523 mm	-



35.011

High hound hurdles

width	length	height	fall height
55 mm	1 000 mm	753 mm	-



35.019

Agility tire jump

width	length	height	fall height
165 mm	1 500 mm	1 620 mm	-



35.004

Wall jumps

width	length	height	fall height
55 mm	910 mm	1 523 mm	-



35.016

Entrance arch for dog parks

width	length	height	fall height
75 mm	1 500 mm	2 505 mm	-



35.014

Adjustable jump bar

width	length	height	fall height
280 mm	916 mm	823 mm	-



35.020

High wait table for dogs

width	length	height	fall height
618 mm	1 218 mm	650 mm	-



35.009

Low wait table for dogs

width	length	height	fall height
618 mm	618 mm	165 mm	-

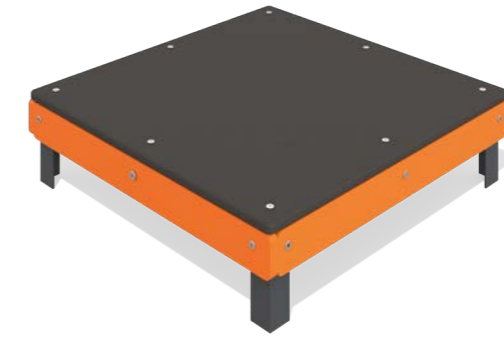

35.003

Maze for dogs

width	length	height	fall height
1 300 mm	5 100 mm	823 mm	-

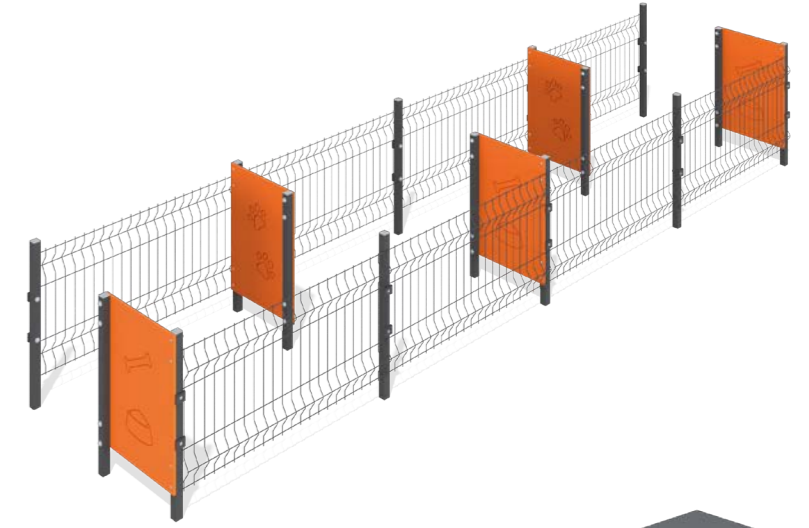

35.002

Dog trash receptacle

width	length	height	fall height
200 mm	280 mm	1 300 mm	-

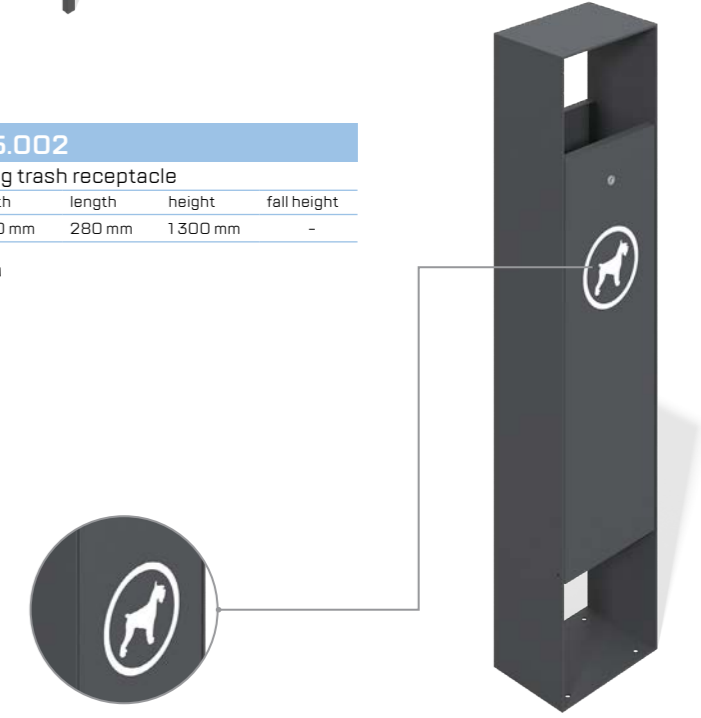

35.001

Dog walk ramp with ladder

width	length	height	fall height
424 mm	6 510 mm	1 275 mm	-

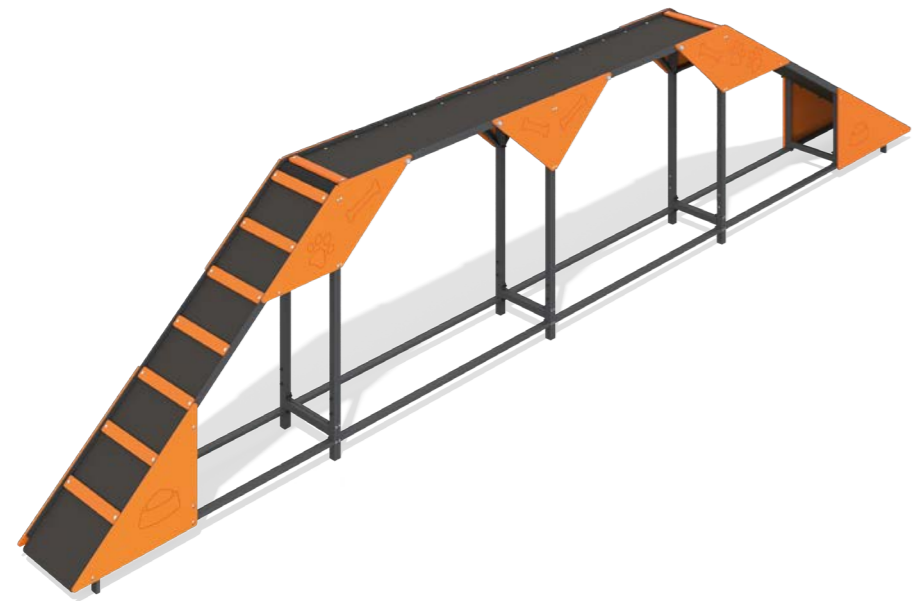

35.012

Dog walk ramp

width	length	height	fall height
424 mm	5 010 mm	1 275 mm	-

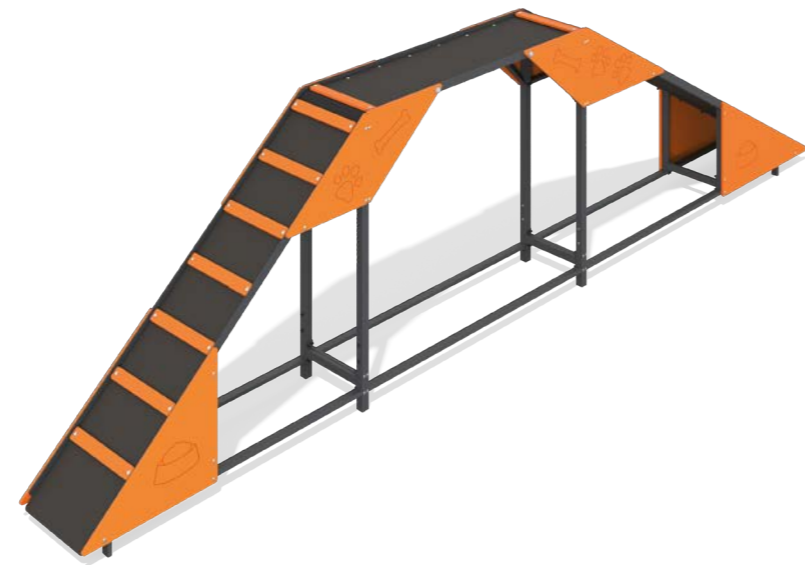

35.005

Small dog walk ramp

width	length	height	fall height
424 mm	2 951 mm	1 275 mm	-

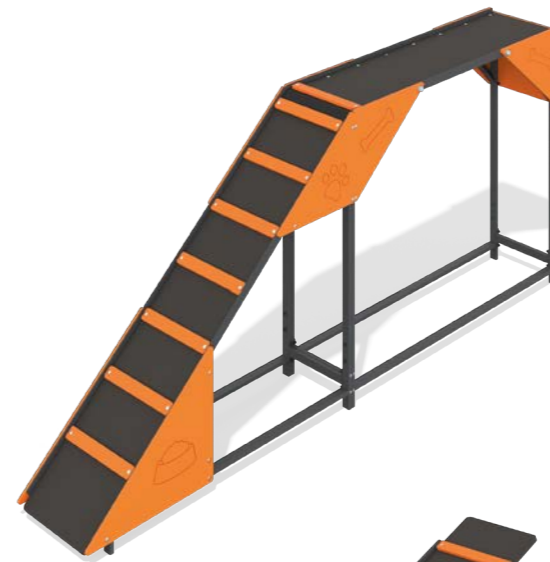

35.018

Dog crawl tunnel 3m

width	length	height	fall height
890 mm	3 015 mm	1 005 mm	-



35.017

Whippet walk

width	length	height	fall height
424 mm	7 110 mm	1 275 mm	-

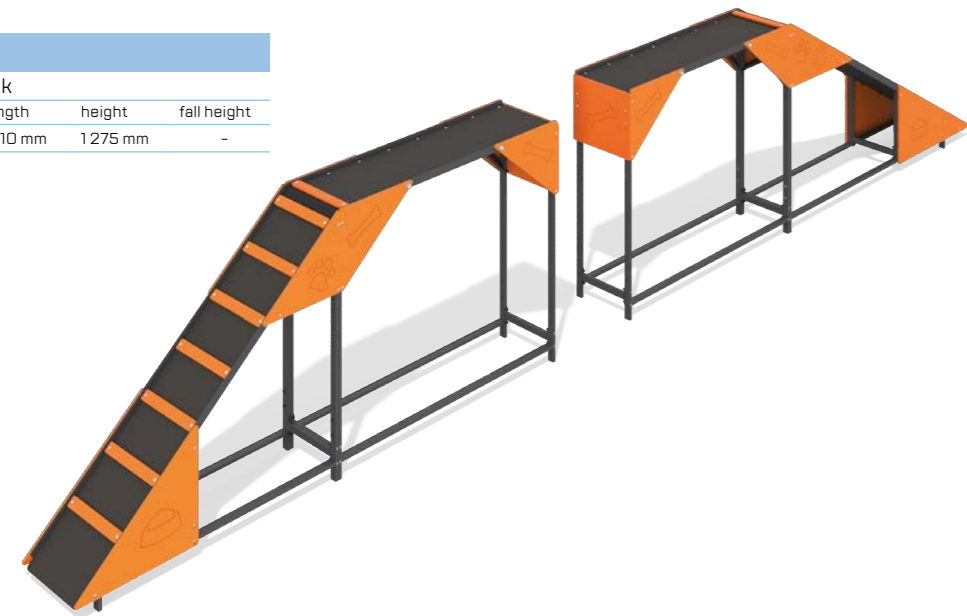

35.010

Dog hill climb

width	length	height	fall height
424 mm	3 510 mm	1 273 mm	-



35.008

Scotie seesaw

width	length	height	fall height
590 mm	2 318 mm	870 mm	-



35.007

Dog crawl tunnel 1.5m

width	length	height	fall height
890 mm	1 515 mm	1 005 mm	-

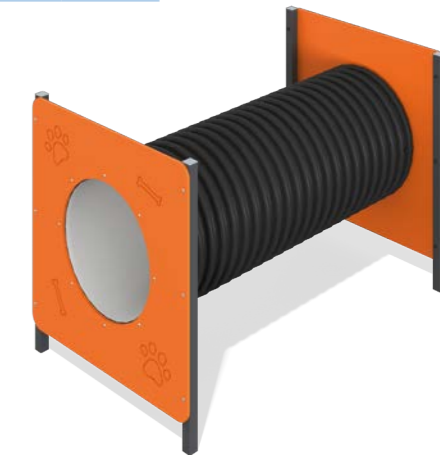

35.006

Agility weave poles

width	length	height	fall height
40 mm	6 080 mm	1 250 mm	-

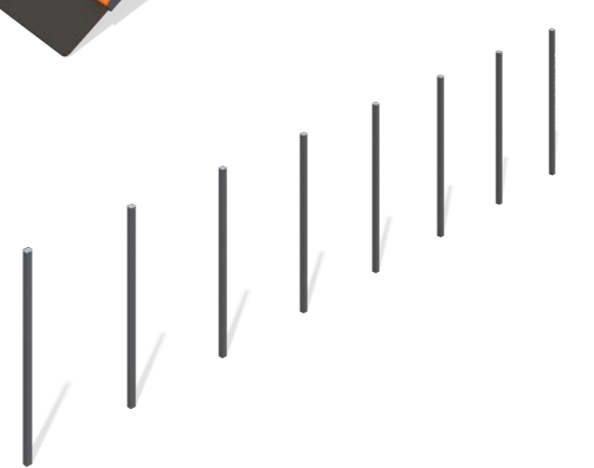



OUTDOOR FURNITURE

32.006**Bike Parking Module Omega**

width	length	height	fall height
750 mm	2 250 mm	800 mm	-

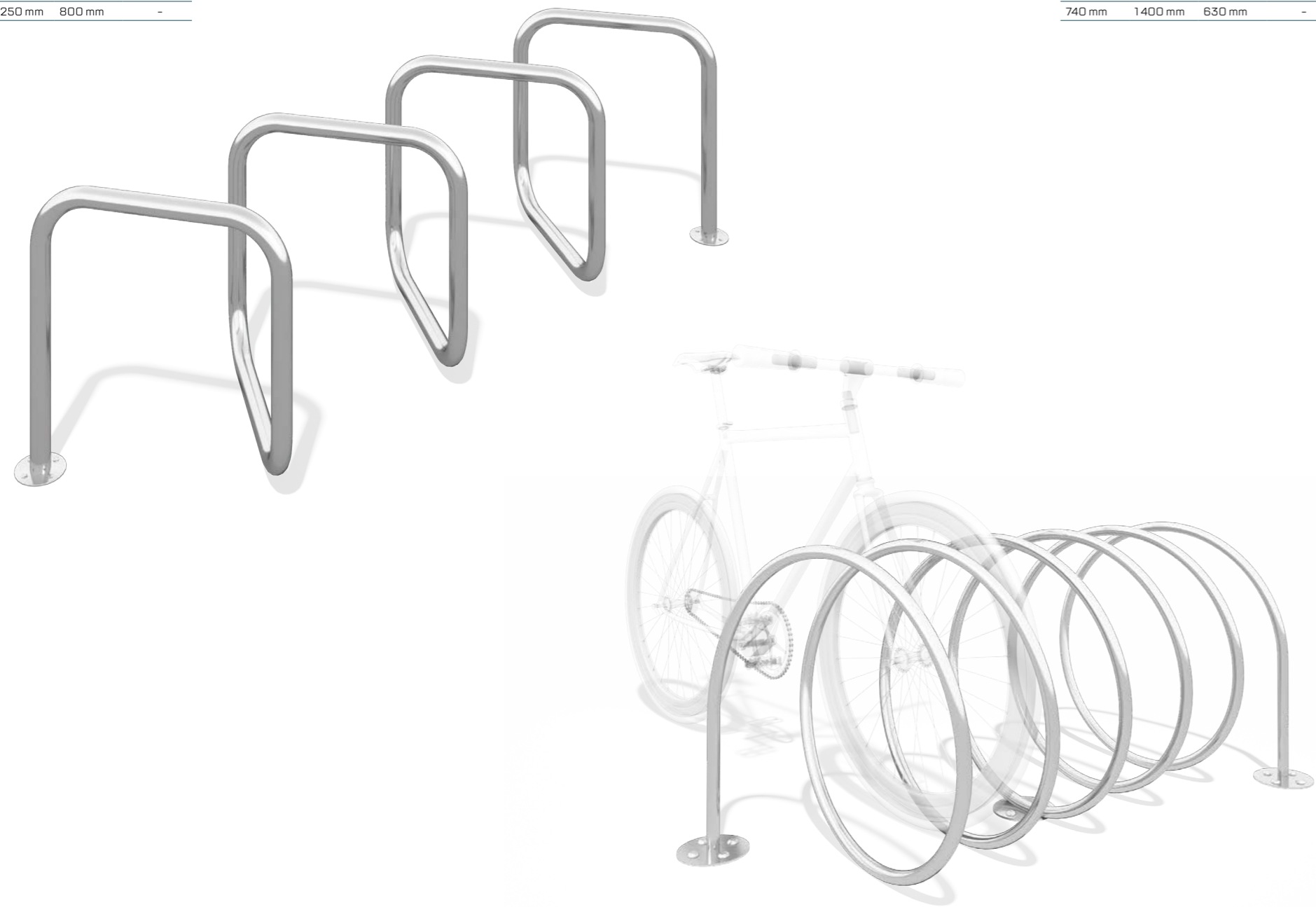
**32.007****Bike Parking Module Alpha**

width	length	height	fall height
740 mm	1 400 mm	630 mm	-

32.008**Bike Parking Module Beta**

width	length	height	fall height
570 mm	1 210 mm	600 mm	-

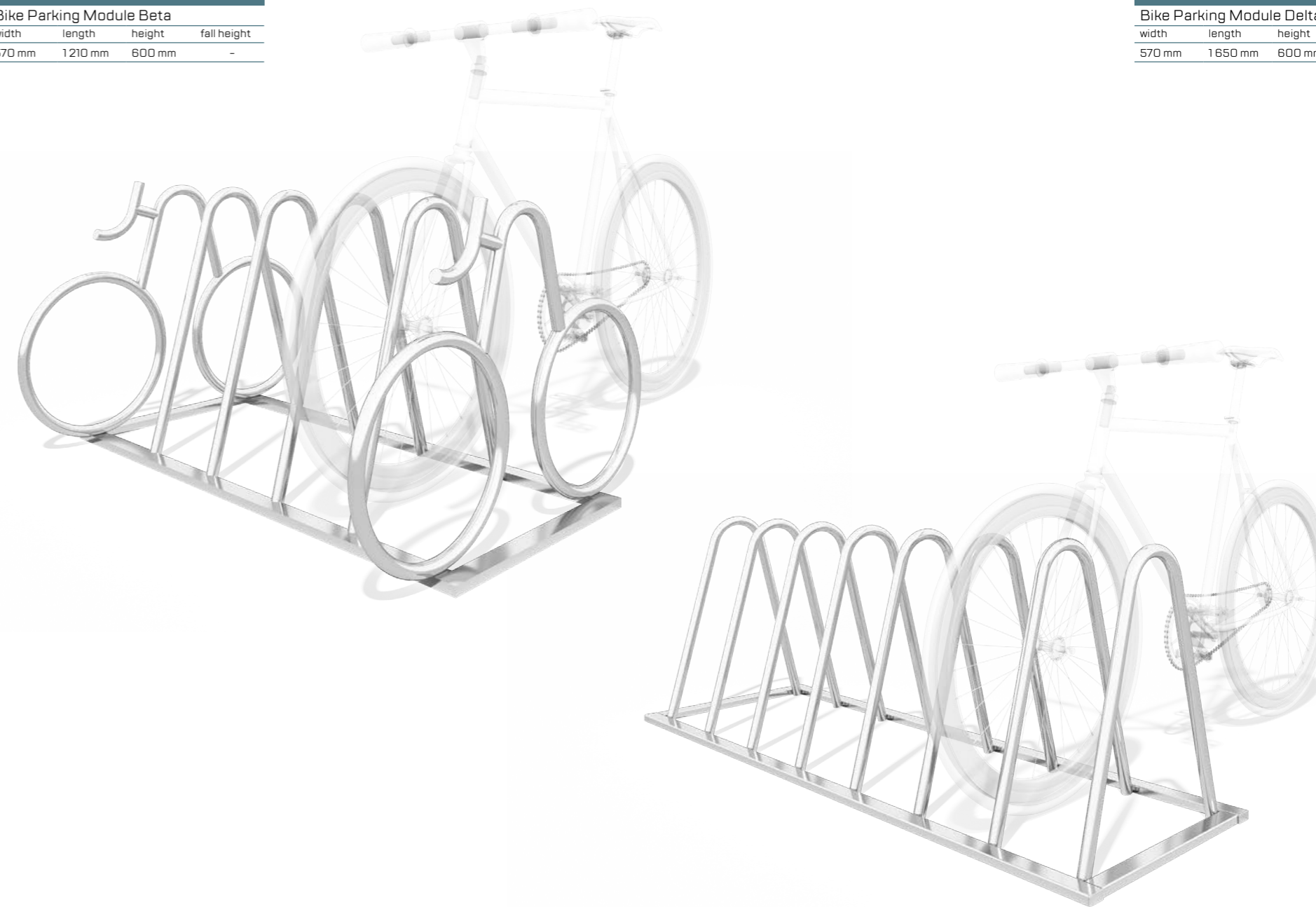
**32.009****Bike Parking Module Delta**

width	length	height	fall height
570 mm	1 650 mm	600 mm	-



32.019

Bicycle parking Tirol

width	length	height	fall height
63 mm	610 mm	1 005 mm	-

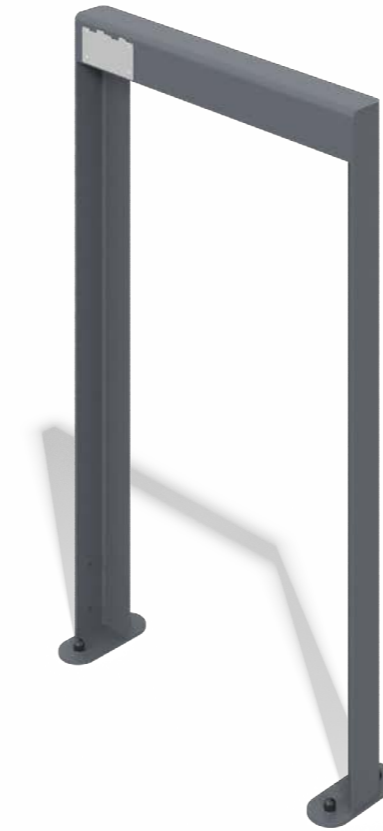

34.479

Park Bench

width	length	height	fall height
400 mm	2 000 mm	453 mm	-



34.478

Park Bench

width	length	height	fall height
400 mm	728 mm	453 mm	-

34.041

Double Park Gazebo

width	length	height	fall height
2 380 mm	4 990 mm	2 754 mm	-



34.047

Canopy Wave

width	length	height	fall height
2 000 mm	2 290 mm	2 610 mm	-



ML6605

Round bin with lid

width	length	height	fall height
350 mm	385 mm	1 030 mm	-



39.092

Recycling triple bin HPL

width	length	height	fall height
1 200 mm	400 mm	1 100 mm	-



34.089

Information Board

width	length	height	fall height
160 mm	713 mm	1 710 mm	-



ML7105

Single bicycle holder

width	length	height	fall height
120 mm	160 mm	950 mm	-



34.483

Park Bench			
width	length	height	fall height
558 mm	1700 mm	853 mm	-

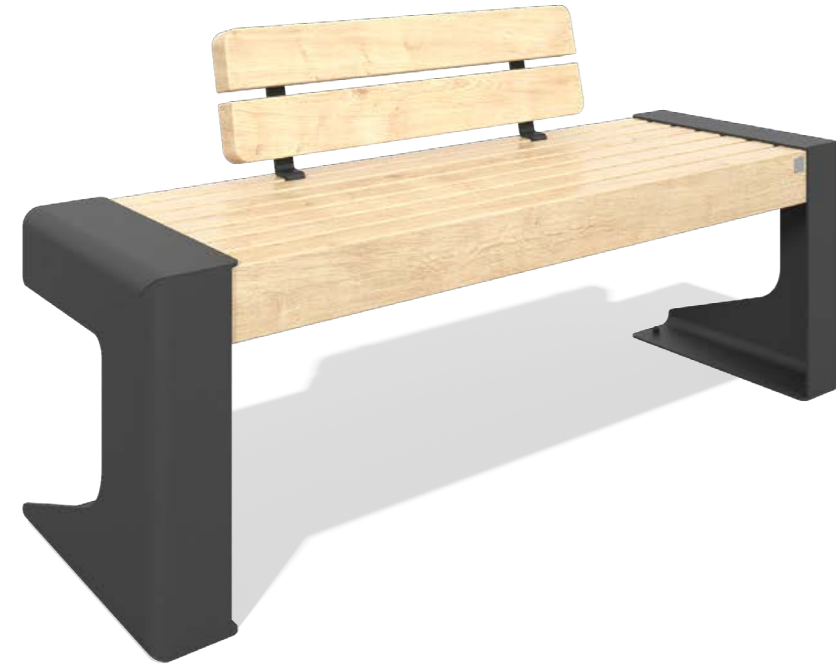

34.484

Park Bench			
width	length	height	fall height
516 mm	1700 mm	560 mm	-

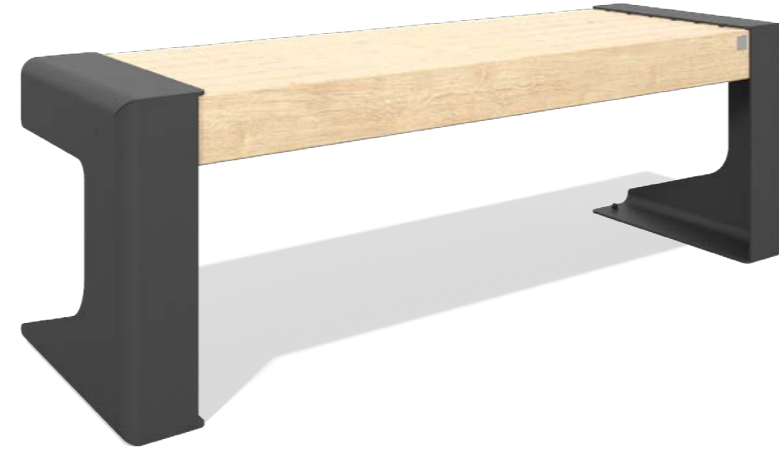

34.486

Park Bench			
width	length	height	fall height
1350 mm	5 094 mm	853 mm	-



34.482

Park Bench			
width	length	height	fall height
690 mm	2 000 mm	405 mm	-



34.485

Park Bench			
width	length	height	fall height
724 mm	2 000 mm	750 mm	-

39.035

Parametric Bin			
width	length	height	fall height
500 mm	500 mm	670 mm	-



39.033

Parametric Bin			
width	length	height	fall height
520 mm	520 mm	670 mm	-



34.406

Parametric Bench			
width	length	height	fall height
1550 mm	3465 mm	850 mm	-



34.408

Parametric Bench			
width	length	height	fall height
870 mm	2650 mm	900 mm	-



39.034

Parametric Bin			
width	length	height	fall height
500 mm	500 mm	620 mm	-



39.031

Parametric Flower pot			
width	length	height	fall height
1900 mm	1900 mm	1200 mm	-



34.410

Parametric Bench			
width	length	height	fall height
1115 mm	8100 mm	750 mm	-

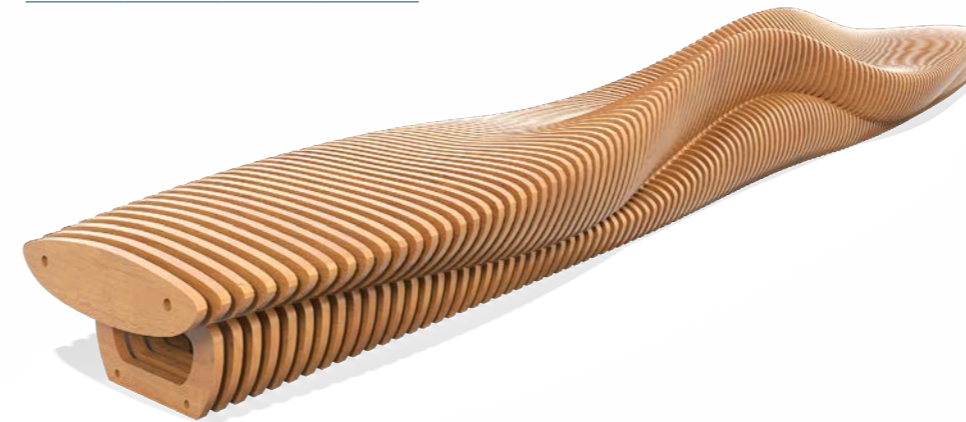

34.405

Parametric Bench			
width	length	height	fall height
3590 mm	3590 mm	590 mm	-

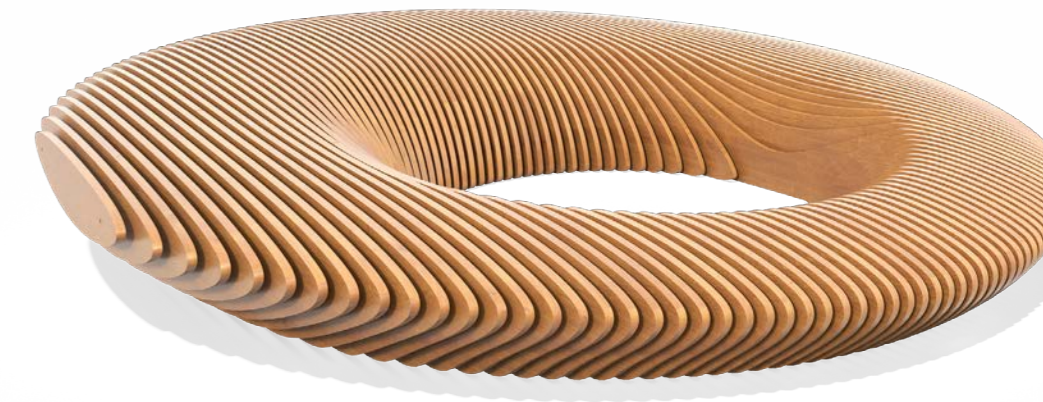

34.305

Sun lounger			
width	length	height	fall height
800 mm	1650 mm	960 mm	-

**34.134**

Concrete park bench Altair			
width	length	height	fall height
1960 mm	2300 mm	460 mm	-

**34.131**

Concrete park bench Hexahedron			
width	length	height	fall height
870 mm	1000 mm	410 mm	-

**34.132**

Concrete park bench Cylinder			
width	length	height	fall height
700 mm	700 mm	450 mm	-

**34.133**

Concrete park bench Spheres			
width	length	height	fall height
1250 mm	3000 mm	450 mm	-

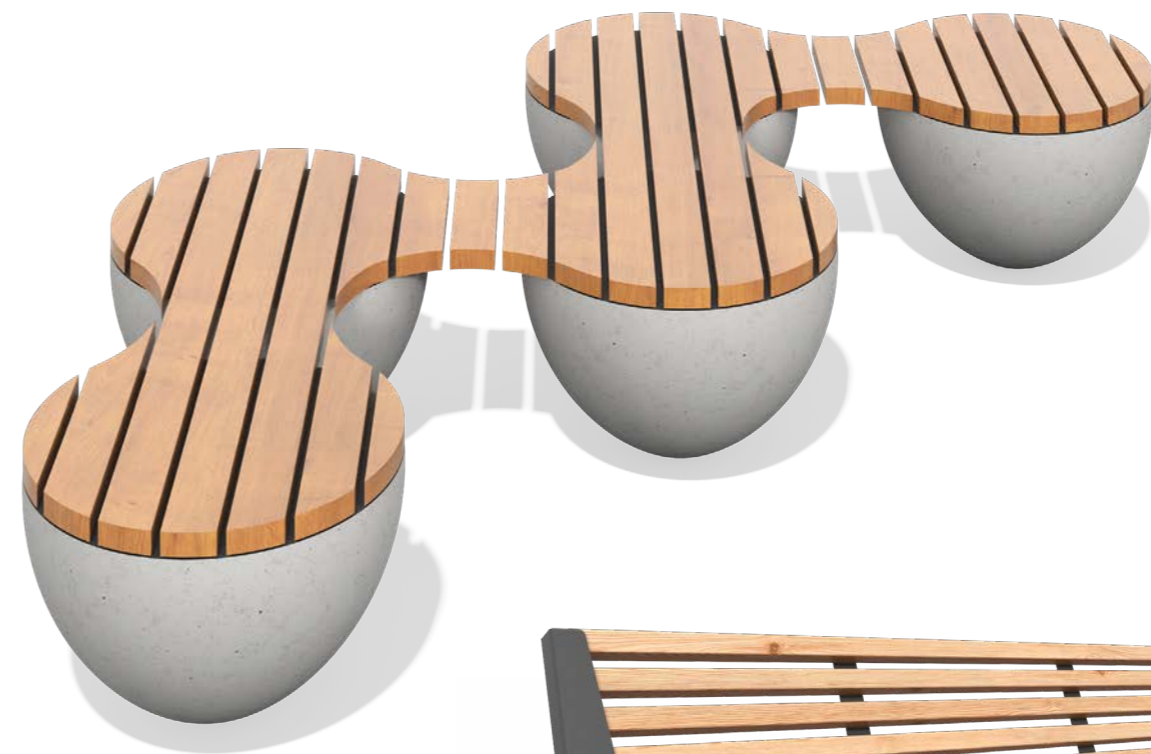
**34.468**

Support bench			
width	length	height	fall height
440 mm	2000 mm	900 mm	-

**34.481**

Park Bench			
width	length	height	fall height
634 mm	2085 mm	888 mm	-



Instagram



Website



WhatsApp



Al Fattan Downtown - 32d St - Al Satwa - Dubai,
P2 office 222

+971 56 796 2427

leber.group